



Medical Catalog

Flexible storage and organization





The art of dividing
and storing with overview
Custom built,
high quality and reliable



Our team is here for you

H+H SYSTEM's diverse and flexible range of organizational systems are developed, designed and produced under one roof. The result? Products which are functional, user-friendly and only of the highest quality standards.

H+H SYSTEM, Inc.

760 Beechnut Drive | Pittsburgh, PA 15205

Phone 412-922-4437 | 800-477-2123

Fax 412-922-4362 | 800-477-9364

salesus@HHsystem.com

www.HHsystem.com



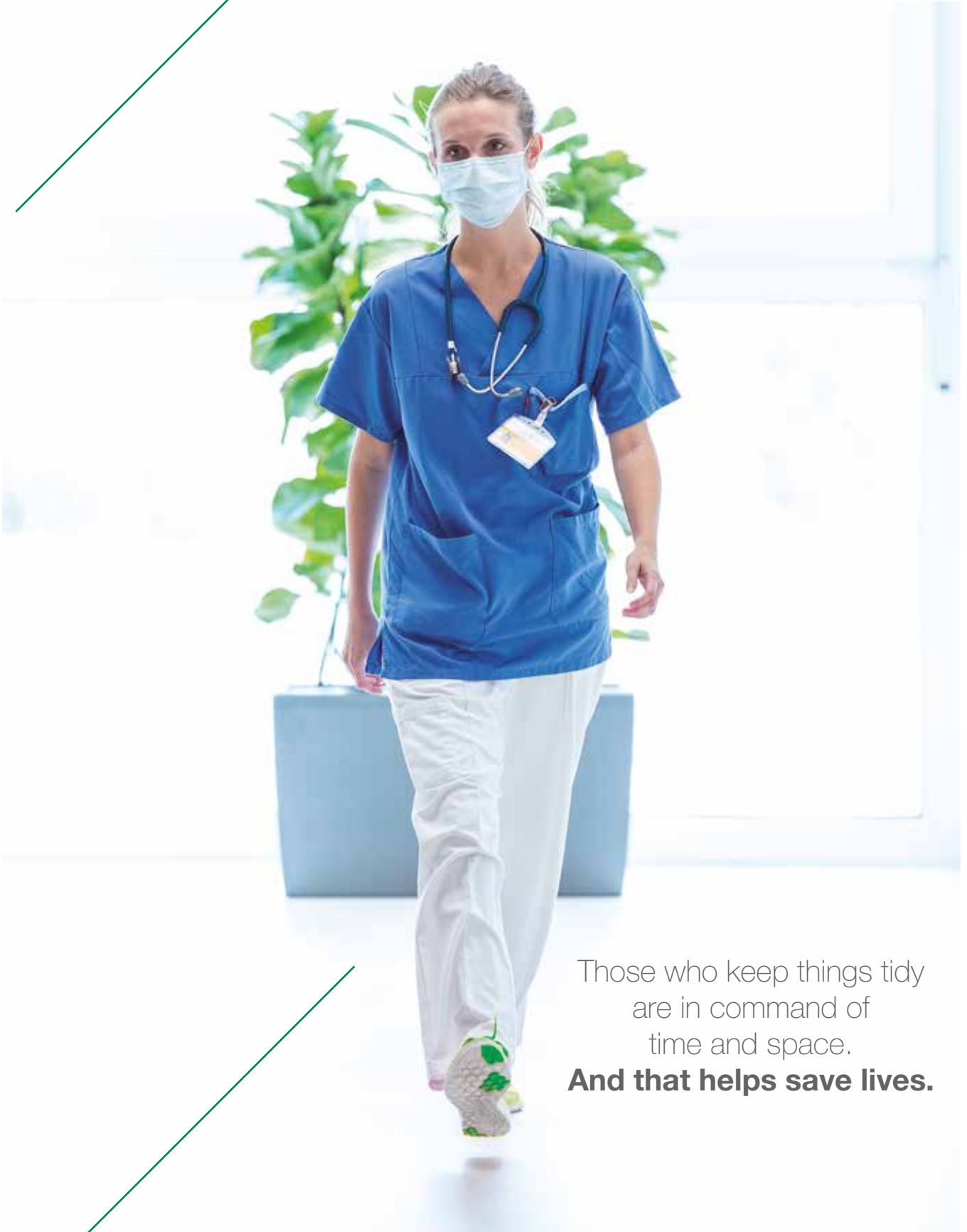

Those who keep things tidy
are in command of
time and space.

And that helps save lives.



Exchange tray workflow

Exchange tray transport and storage, drug storage, picking/checking stations, IT stations, tray prep, bulk storage



from page 06

1

Cart and drawer organization

Standard tray and divider set-ups for all carts, MedTray custom trays with flexible dividers, security options, drawer divider kits with insert and with slotted rail holder, divider, clips and rails



from page 08

2

H+H FlexShelf for storage and work

Storage shelves, workstations, mobile units, configurator, H+H FlexShelf MHD

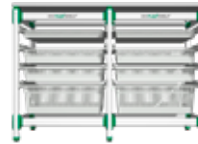

from page 32

3

Modular tray system in ISO

Modular tray system in ISO, dividers for ISO modular trays, accessories, labeling, full extension runners, side panels



from page 38

4

Bins and boxes

Storage bins, shelf bins, medication briefcases, narcotic boxes, elibox

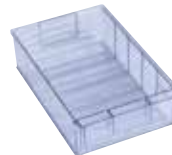

from page 58

5

Flexible shelf dividers

Dividers with closed front, dividers with closed back, dividers with aluminum front rail



from page 64

6

Labeling and logistics

Label holders, labels, labeling rails



from page 66

7

Refrigerator storage

AluCool® drawer, H+H MedTray, plastic drawer, blood bank dividers, cold room organization



from page 72

8

Medication distribution

Medication aids



from page 76

9

Human barrier products

V-shield, v-shield plus, v-shield pro commercial



from page 80

10

Exchange tray workflow

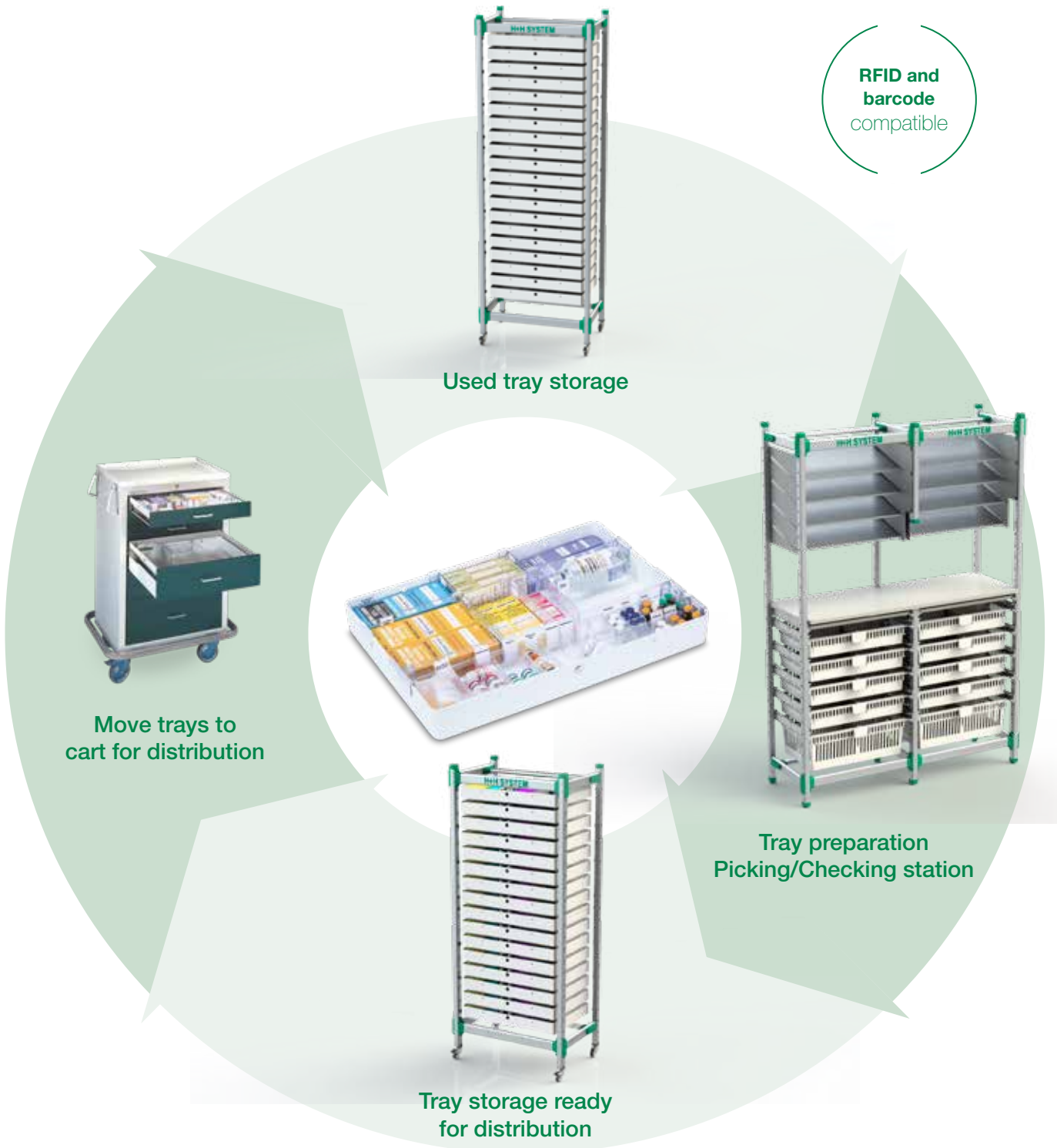

Exchange tray transport and storage



Drug storage



Picking/checking stations



IT stations, tray prep, bulk storage



Configure your own workspace

| See H+H FlexShelf chapter





Cart and drawer organization

- | Space savings of 30% with flexible divider system
- | Custom fit for any manufacturers cart
- | For any drawer type and size
- | Easily adjustable to changing space requirements
- | Optimal overall view and quick access to products

Perfect overview
and space saving
organization in your cart

Custom MedTray and molded standard tray
with dividers



Dividers with insert



Dividers with slotted rail holder



Design your own drawer organization

Let us transform your work space

Discover our
online 3D planner

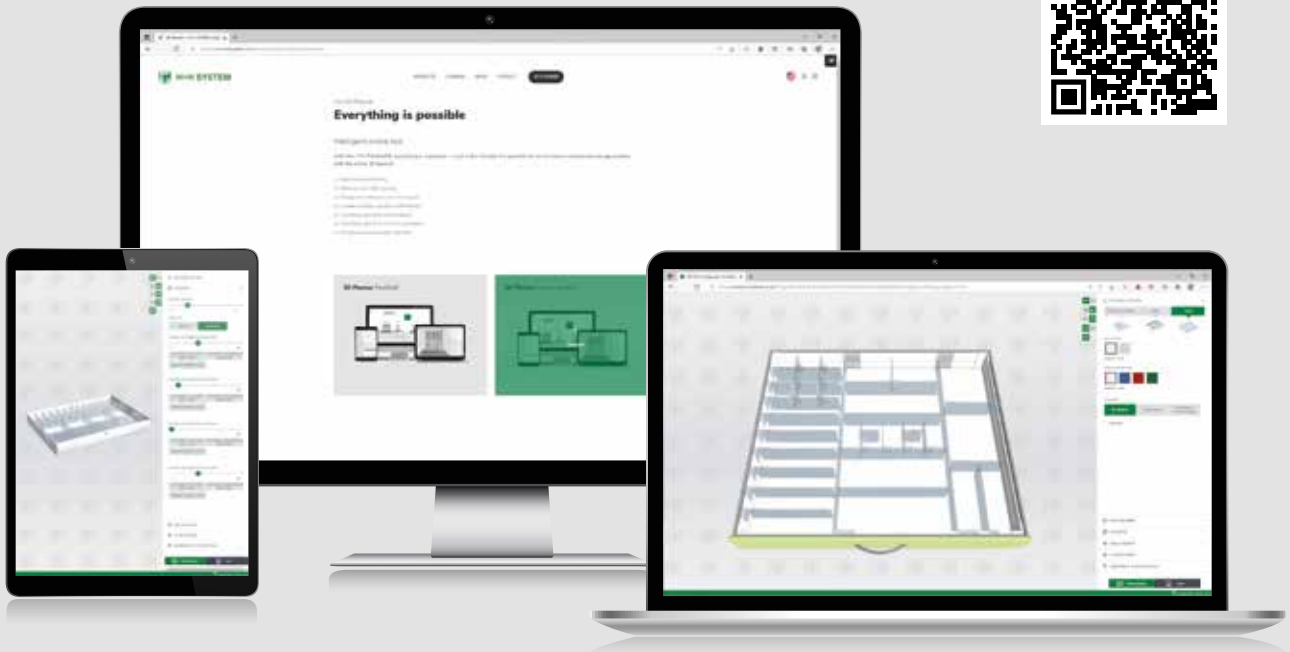

Trays



Drawer divider kits with insert



Drawer divider kits with slotted rail holder

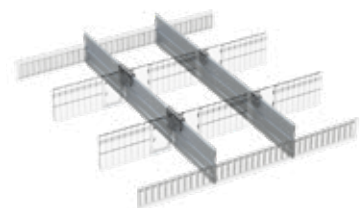

Standard tray and divider set-ups for all carts

- Standard tray size: 21 1/2 x 15 1/4 x 2 5/16"
- Save up to 30% space
- Flexible dividers are removable and adjustable, which can be customized to accommodate changes
- Ensure accuracy and reduce risk of med errors
- Provide security and control of meds
- Improve overall efficiency by maintaining organization and expediting inventory

Security bags



| Art. No. | Description |
|----------|--|
| 830020 | For standard trays with height 2 5/16" |
| 830019 | For standard trays with height 5" |

More sizing available under security options



Standard molded tray set-up

- Simple set-up used to hold bulkier and larger boxes, usually found in second or third drawer
- 9 compartments
- Includes tray and flexible dividers

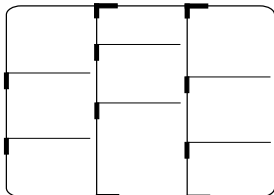

| Art. No. | Description | Size (W x D x H) |
|-------------|-------------|-----------------------------|
| 890101 | White | 21 1/2" x 15 1/4" x 2 5/16" |
| 890000-AAI8 | Blue | 21 1/2" x 15 1/4" x 2 5/16" |
| 890000-AAL5 | Red | 21 1/2" x 15 1/4" x 2 5/16" |

Standard molded tray set-up with ampule dividers

- Usually used in second drawer for uncontrolled meds that can be stocked by a Pharmacy Tech. This tray can be used in the first drawer for exchange if not using a lot of vials and ampules
- 25 compartments
- Includes tray and flexible dividers

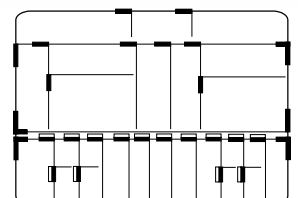

| Art. No. | Description | Size (W x D x H) |
|-------------|-------------|-----------------------------|
| 890000-AAG2 | White | 21 1/2" x 15 1/4" x 2 5/16" |
| 890000-AAG6 | Blue | 21 1/2" x 15 1/4" x 2 5/16" |
| 890000-ADR5 | Red | 21 1/2" x 15 1/4" x 2 5/16" |

Standard molded exchange tray set-up

| The tray may be sealed with a tamper evident security bag or a plexi-lid locked with security seals. When the bag or the seals are broken the tray is taken to the pharmacy and exchanged for a sealed tray

| 29 compartments

| Includes tray and flexible dividers

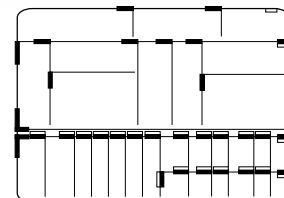

| Art. No. | Description | Size (W x D x H) |
|-------------|-------------|-----------------------------|
| 890000-AAG3 | White | 21 1/2" x 15 1/4" x 2 5/16" |
| 890000-ABL7 | Blue | 21 1/2" x 15 1/4" x 2 5/16" |
| 890000-ABN4 | Red | 21 1/2" x 15 1/4" x 2 5/16" |



Standard molded tray anesthesia set-up

| H+H recommends this set-up for anesthesia because of the numerous drugs that are stored for OR cases in the cart. It can also be sealed with a security bag or plexi-lid and can be exchanged with the pharmacy

| 43 compartments

| Includes tray and flexible dividers

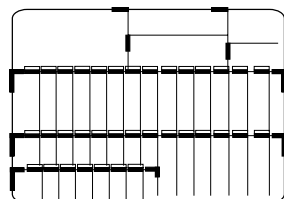

| Art. No. | Description | Size (W x D x H) |
|-------------|-------------|-----------------------------|
| 890000-AAG4 | White | 21 1/2" x 15 1/4" x 2 5/16" |
| 890000-AAPO | Blue | 21 1/2" x 15 1/4" x 2 5/16" |
| 890000-ACA7 | Red | 21 1/2" x 15 1/4" x 2 5/16" |

5" high standard tray set-up

| This tray is usually found in the bottom drawers, which range from 6" to 9" high. IV bags, air tubes, large boxes, etc. are usually stored in this tray. This tray can be used in anesthesia as well as code and crash carts

| 9 compartments

| Includes tray and flexible dividers

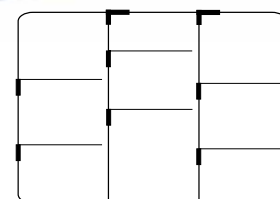
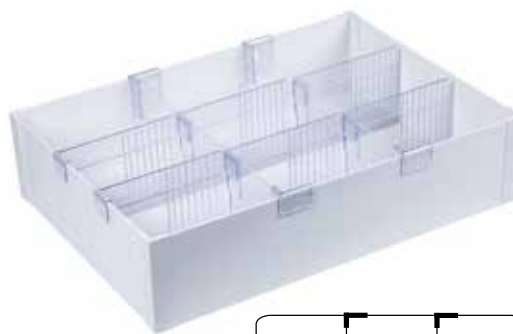

| Art. No. | Description | Size (W x D x H) |
|-------------|-------------|------------------------|
| 860500-AAG0 | White | 21 1/2" x 15 1/4" x 5" |

| Art. No. | Description | Size (W x D x H) |
|----------|-------------|-----------------------------|
| 890001 | White | 21 1/2" x 15 1/4" x 2 5/16" |
| 890001B | Blue | 21 1/2" x 15 1/4" x 2 5/16" |
| 890001R | Red | 21 1/2" x 15 1/4" x 2 5/16" |



Standard trays (empty)



MedTray

custom trays with flexible dividers

- | Quick and easy to exchange (exchange tray system)
- | Flexible dividers
- | Any size
- | Labeling options
- | Different designs and materials
- | Optional colored corners

Patient-friendly storage
using space rationally

Thanks to their flexibility, these trays enable sustainable order in all drawers



The entire tray is easily removable ensuring quick cleaning for optimal hygiene at all times



Customized to your requirements:
We manufacture your MedTrays according to your exact specifications for a perfect fit

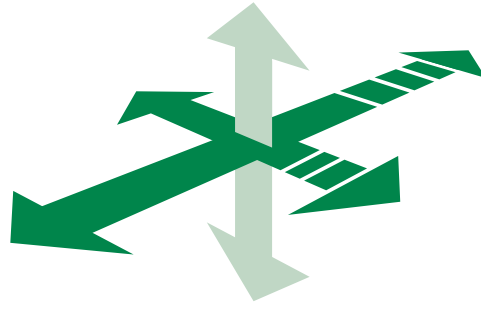

- | For all drawers
- | Possible with any dividing system
- | Available in white with optional colored corners
- | Other colors on request

For system heights:

- 1 3/8" (35 mm)
- 2 5/16" (55 mm)
- 4" (100 mm)
- 5" (125 mm)
- 6" (150 mm)
- 8" (200 mm)
- 10" (250 mm)

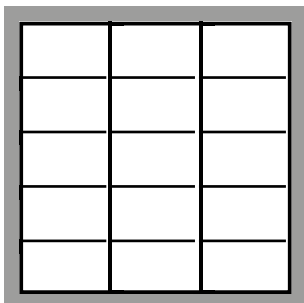

Subdivision lengthwise
3 lanes

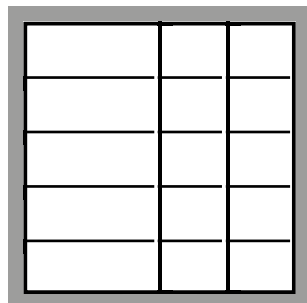

Subdivision lengthwise
3 lanes

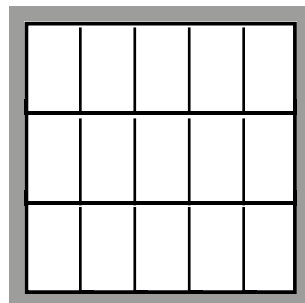

Subdivision crosswise
3 lanes

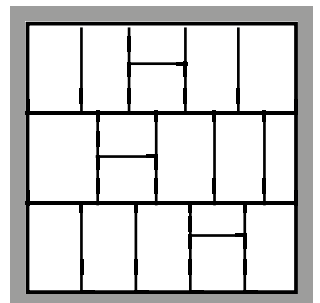

Subdivision crosswise
3 lanes

H+H MedTray system height 1 3/8"

- Flexible dividers
- Any size and configuration possible
- Corners available in white, blue, green and red

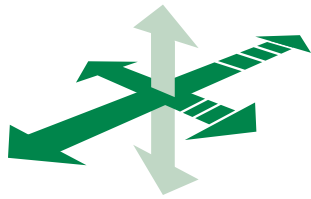

Any width
Any depth
Any height



Sample photo

Corner clip color options

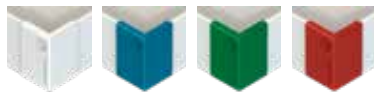

H+H MedTray system height 2 5/16"

- Flexible dividers
- Any size and configuration possible
- Corners available in white, blue, green and red

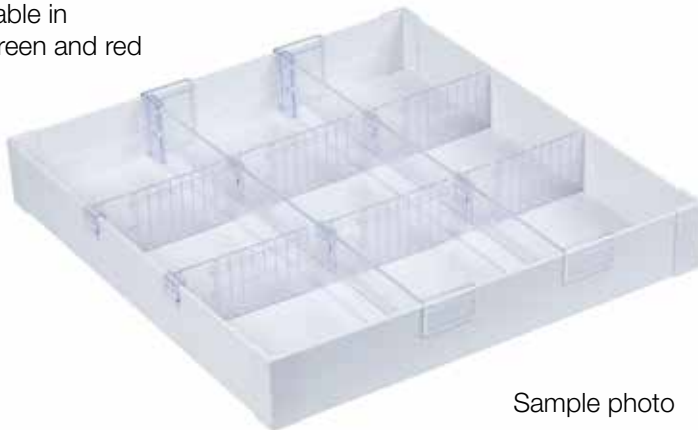

Sample photo

Trays for drawers in all widths and depths:

Made of durable plastic, easy to clean and with flexible dividers



H+H MedTray system height 4"

- Flexible dividers
- Any size and configuration possible
- Corners available in white, blue, green and red



Sample photo

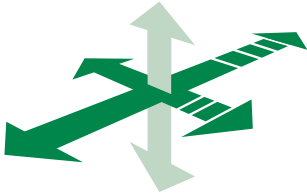

Any width
Any depth
Any height

Corner clip color options

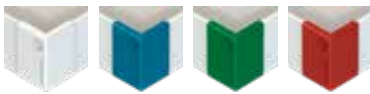

H+H MedTray system height 5"

- Flexible dividers
- Any size and configuration possible
- Corners available in white, blue, green and red

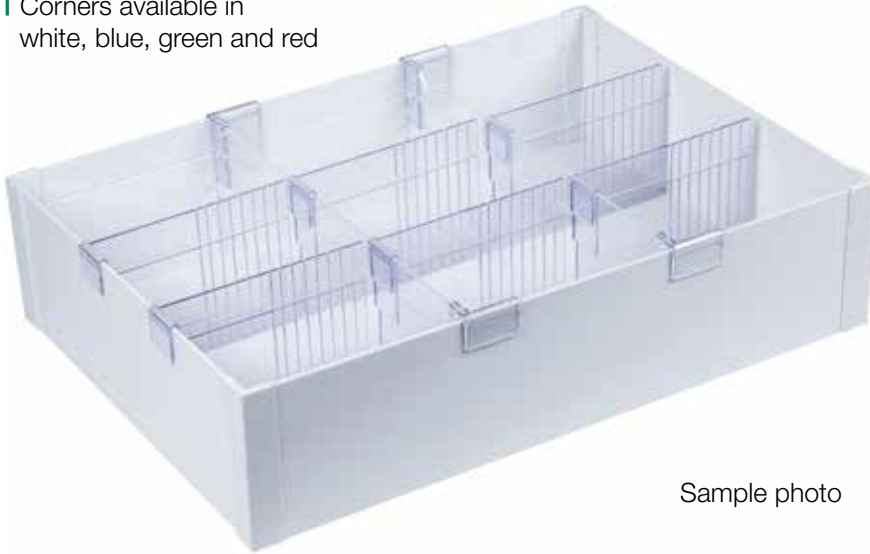

Sample photo

Design your personal
H+H MedTray with us:
**All MedTrays for
your drawers,
carts and
applications are
designed to your
exact specifications**





Security bags for trays

- | Tamper evident bags help secure meds and narcotics
- | Ensure tray accuracy and hygiene in the transport process
- | Adhesive seal
- | Bags with perforation for easy access to your trays and meds
- | Quickly identify if trays have been used or tampered with

| Art. No. | pack or case qty | Fits tray size up to | Description | Bag size |
|------------|------------------|---------------------------|--------------------------------|------------------|
| 830018-P | 20 pcs | 14 x 16 x 2 5/16" | Bag 861 clear | 18 1/2 x 16 1/2" |
| 830018-C | 900 pcs | | | |
| 830019L-P | 20 pcs | 21 1/2 x 15 1/4 x 5" | Bag 850 clear, long | 22 x 30" |
| 830019L-C | 500 pcs | | | |
| 830019R-P | 20 pcs | 21 1/2 x 15 1/4 x 5" | Bag 850 clear with red stripe | 21 3/4 x 25" |
| 830019R-C | 600 pcs | | | |
| 830019UV-P | 20 pcs | 21 1/2 x 15 1/4 x 5" | Bag 850 bronze (UV resistant) | 21 3/4 x 25" |
| 830019UV-C | 600 pcs | | | |
| 830020-P | 20 pcs | 21 1/2 x 15 1/4 x 2 5/16" | Bag 852 clear | 19 1/4 x 22" |
| 830020-C | 700 pcs | | | |
| 830020B-P | 20 pcs | 21 1/2 x 15 1/4 x 2 5/16" | Bag 852 clear with blue stripe | 19 1/4 x 22" |
| 830020B-C | 700 pcs | | | |
| 830020R-P | 20 pcs | 21 1/2 x 15 1/4 x 2 5/16" | Bag 852 clear with red stripe | 19 1/4 x 22" |
| 830020R-C | 700 pcs | | | |
| 830020UV-P | 20 pcs | 21 1/2 x 15 1/4 x 2 5/16" | Bag 852 bronze (UV resistant) | 19 1/4 x 22" |
| 830020UV-C | 700 pcs | | | |
| 830021-P | 20 pcs | 10 x 15 1/4 x 2 5/16" | Bag 842 clear | 13 3/4 x 19" |
| 830021-C | 1300 pcs | | | |
| 830022B-P | 20 pcs | 18 x 17 x 2 5/16" | Bag 862 clear with blue stripe | 21 1/4 x 18 1/2" |
| 830022B-C | 800 pcs | | | |
| 830025-P | 20 pcs | 21 1/2 x 17 x 2 5/16" | Bag 882 clear | 22 x 22" |
| 830025-C | 700 pcs | | | |
| 830026-P | 20 pcs | 21 1/2 x 17 x 5" | Bag 880 clear | 26 x 25" |
| 830026-C | 500 pcs | | | |



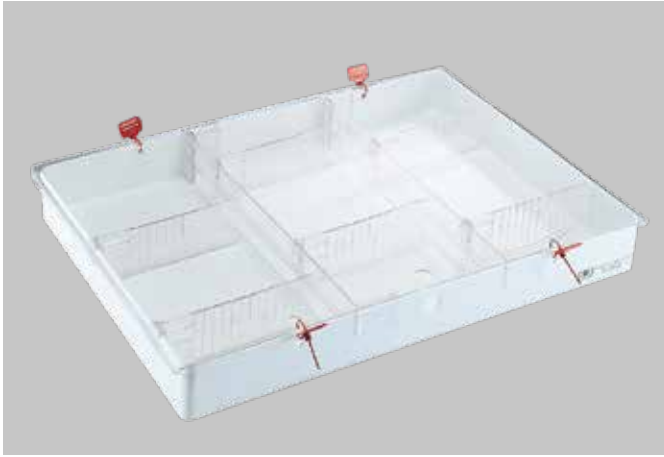

Lids for standard trays

- | The ends of the lids extend over edge of tray
- | Front and back of the lid have two holes, each for securing the lid to the tray with seals
- | Lid stops for back of tray eliminate the need for 2 seals in back of tray
- | Bronze lids are UV resistant to protect sensitive drugs

| Art. No. | Description | For trays |
|-------------|-------------|-------------------|
| 880000-AAA4 | Bronze | 21 1/2" x 15 1/4" |
| 880000-AAA5 | Clear | 21 1/2" x 15 1/4" |

Lids for customized MedTrays

- | Any size of lid is available
- | The ends of the lids extend over edge of tray
- | Front and back of the lid have two holes, each for securing the lid to the tray with seals
- | Lid stops for back of tray eliminate the need for 2 seals in back of tray
- | Bronze lids are UV resistant to protect sensitive drugs

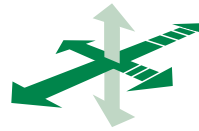

Tearaway seals long for lids

- | In different colors
- | Serial numbered for tracking
- | Quantity per pack: 100 pcs

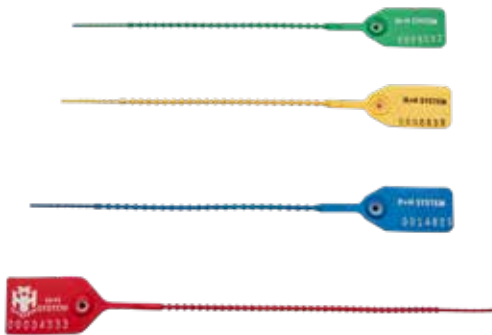

| Art. No. | Description |
|----------|-----------------|
| 840021B | Blue, 8" long |
| 840021G | Green, 8" long |
| 840021R | Red, 8" long |
| 840021Y | Yellow, 8" long |

Tearaway seals square for lids

- | In different colors
- | Serial numbered for tracking
- | Quantity per pack: 100 pcs

| Art. No. | Description |
|----------|-------------|
| 840022G | Green |
| 840022R | Red |
| 840022Y | Yellow |





Drawer divider kits with insert

- | To retrofit any drawer
- | Custom designed for any height
- | Dividers lengthwise or crosswise
- | Delivered completely assembled, self assembly also possible
- | Fully flexible inner configuration of your drawers
- | Width and depth adjustable

Removable and
easy to clean

The frame, rails and dividers are made of transparent plastic



Easily remove the entire insert in one simple action



Divider system height 1 3/8"

- Frame, rails and dividers come in transparent plastic
- Dividers are designed according to your exact specifications
- Flexible sliding divider: transparent plastic, to "scratch and break" at the desired length

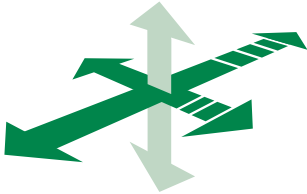

Any width
Any depth
Any height



Sample photo

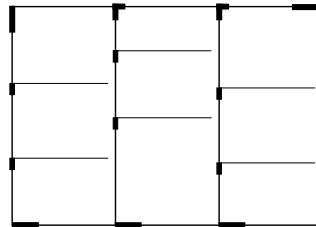

1 3/8" high standard divider kit

- 3 rows, 6 horizontal dividers
- 9 compartments

| Art. No. | Dimensions |
|-------------|--------------------|
| 500201-AAM9 | 22" x 16" x 1 3/8" |

1 3/8" high standard divider kit

- 4 rows, 12 horizontal dividers
- 16 compartments

| Art. No. | Dimensions |
|-------------|--------------------|
| 500201-AAN0 | 22" x 16" x 1 3/8" |

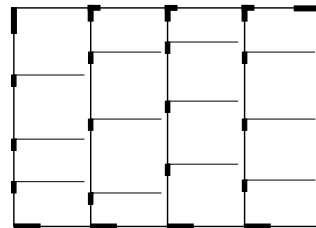

Kits for anesthesia drawers

- We produce customized divider kits to fit your width, depth, and height needs



Any width
Any depth
Any height

Divider system height 2 5/16"

- Frame, rails and dividers come in transparent plastic
- Dividers are designed according to your exact specifications
- Flexible sliding divider: plastic transparent, to "scratch and break" at the desired length



Sample photos

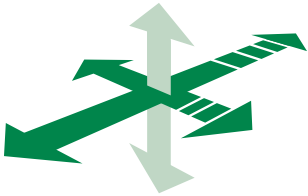

Any width
Any depth
Any height

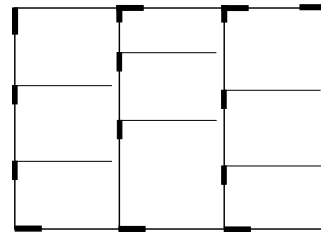

2 5/16" high standard divider kit

- 3 rows, 6 horizontal dividers
- 9 compartments

| Art. No. | Dimensions |
|-------------|---------------------|
| 500201-AAD8 | 22" x 16" x 2 5/16" |

Divider system height 4"



We started building
our expertise over
forty years ago
**with our patented
sliding divider**

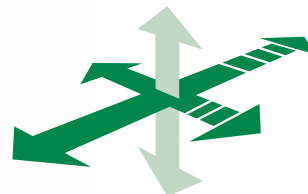

Any width
Any depth
Any height

Divider system height 5"

- | Frame, rails and dividers come in transparent plastic
- | Dividers are designed according to your exact specifications
- | Flexible sliding divider: plastic transparent, to "scratch and break" at the desired length

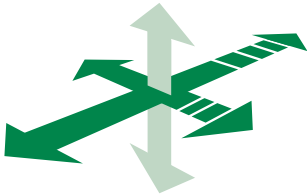

Any width
Any depth
Any height

Sample photos

5" high standard divider kit

- | 3 rows, 6 horizontal dividers
- | 9 compartments

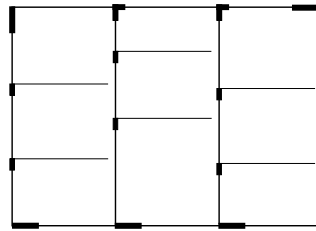

| Art. No. | Dimensions |
|-------------|----------------|
| 500201-AAF6 | 22" x 16" x 5" |

Divider system height 6", 8", 10"

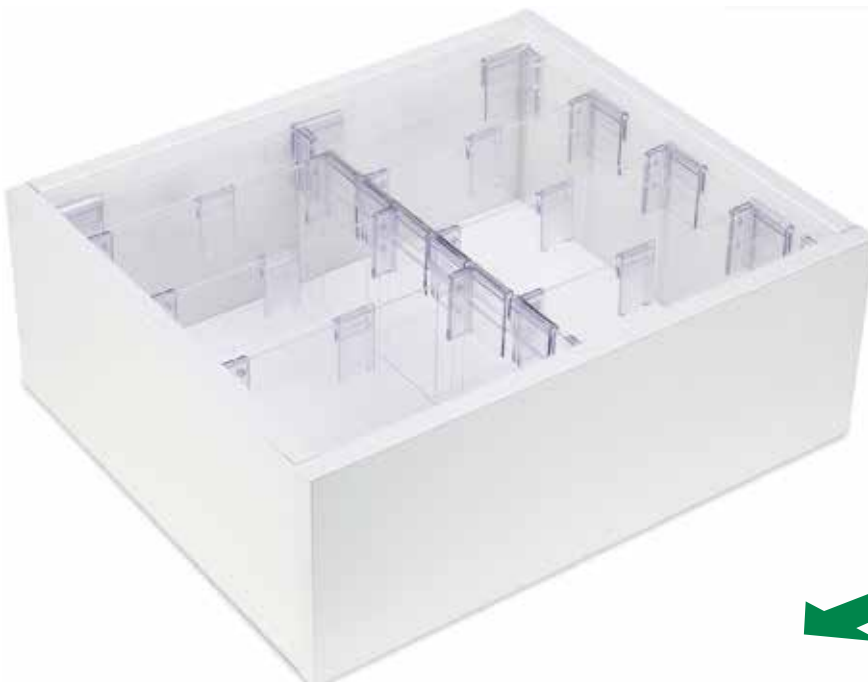

Regardless of the drawer's dimensions:
Our dividers adapt to suit your requirements

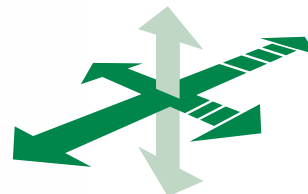

Any width
Any depth
Any height



Drawer divider kits with slotted rail holder

- | Organization and flexibility
- | Custom division
- | Adjustable width and depth at any time
- | For existing drawers of any size
- | Sizes according to your exact specifications
(Inside drawer dimensions - width, depth, height)

Space savings of
up to 30% thanks
to H+H SYSTEM's
drawer dividers

It's that easy:

Simply cut the slotted rail holder to the required length and use the double-sided tape to stick it inside the drawer

Slide your custom-cut aluminum rail into the slotted rail holder





Just ask!
Our experts are here to help you create the perfect dividing system to match your requirements exactly

Divider system height 1 3/8"

- | Slotted rail holder: transparent plastic with adhesive tape, for customization
- | Aluminum rail: pre-cut and customized according to your drawer's inside dimensions
- | Flexible sliding divider: transparent plastic, to scratch and break at the desired length

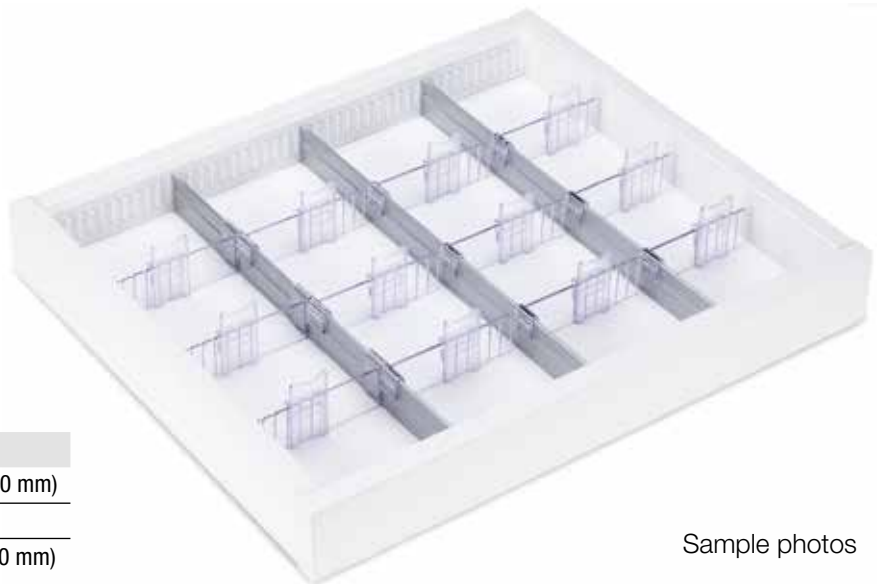

Sample photos

| Art. No. | Designation | Size |
|------------|---------------------|---------------------|
| 220102N-PA | Slotted rail holder | L=19 9/32" (490 mm) |
| 200103U | Aluminum rail | Drawer depth |
| 240161 | Sliding divider | L=6 11/16" (170 mm) |

Clip the flexible sliding divider on the aluminum rail. It's easy to move and adapts perfectly to your products



The flexible ends make removing products a breeze



Divider system height 2 5/16"

- Slotted rail holder: transparent plastic with adhesive tape, for customization
- Aluminum rail: pre-cut and customized according to your drawer's inside dimensions
- Flexible sliding divider: transparent plastic, to scratch and break at the desired length

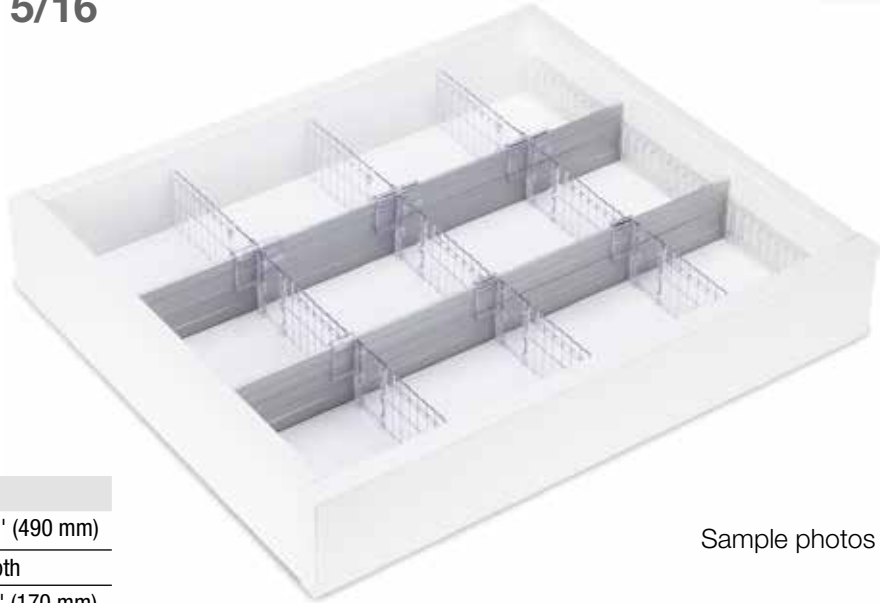

Sample photos

| Art. No. | Designation | Size |
|------------|---------------------|---------------------|
| 220102N-PA | Slotted rail holder | L=19 9/32" (490 mm) |
| 200101U | Aluminum rail | Drawer depth |
| 240087 | Sliding divider | L=6 11/16" (170 mm) |

Divider system height 4"

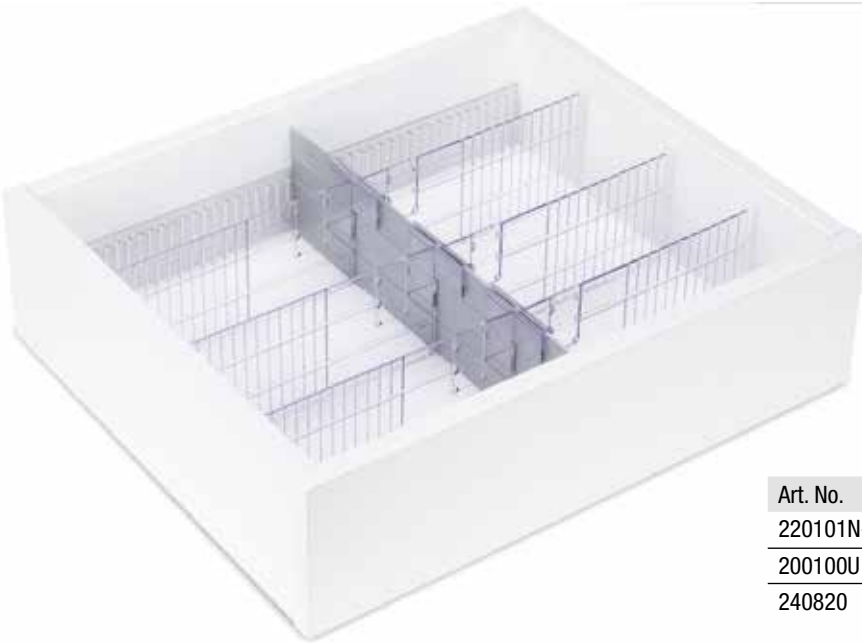

Our subdivision expertise began over forty years ago with our patented **sliding divider**

| Art. No. | Designation | Size |
|------------|---------------------|---------------------|
| 220101N-PA | Slotted rail holder | L=19 9/32" (490 mm) |
| 200100U | Aluminum rail | Drawer depth |
| 240820 | Sliding divider | L=6 11/16" (170 mm) |

Examples of subdivision:

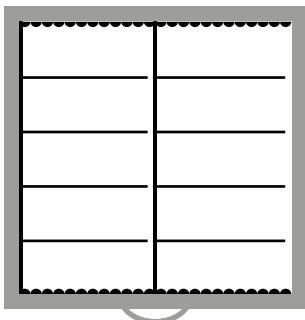

Subdivision lengthwise
2 lanes

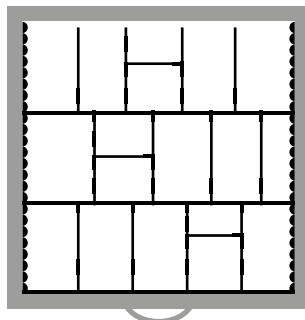

Subdivision crosswise
3 lanes

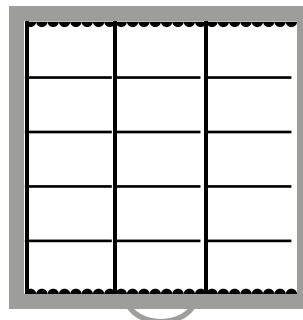

Subdivision lengthwise
3 lanes

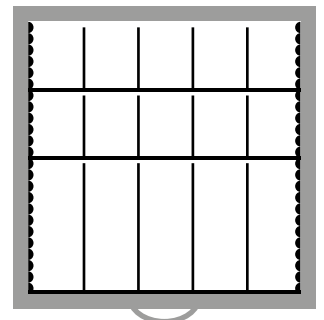

Subdivision crosswise
3 lanes

Divider system height 5"

- | Slotted rail holder: transparent plastic with adhesive tape, for customization
- | Aluminum rail: pre-cut and customized according to your drawer's inside dimensions
- | Flexible sliding divider: transparent plastic, to scratch and break at the desired length

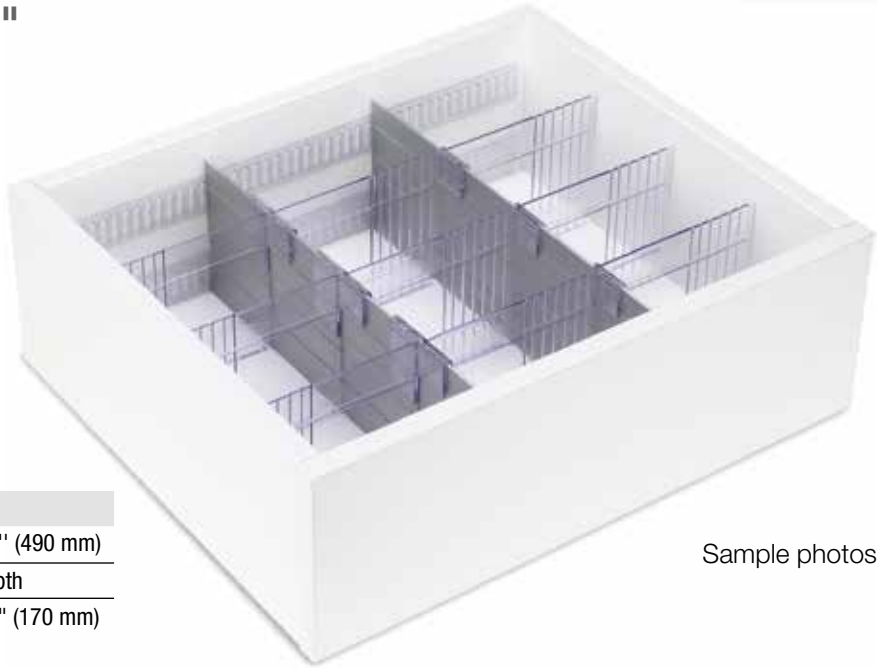

Sample photos

| Art. No. | Designation | Size |
|------------|---------------------|---------------------|
| 220101N-PA | Slotted rail holder | L=19 9/32" (490 mm) |
| 200098U | Aluminum rail | Drawer depth |
| 240880 | Sliding divider | L=6 11/16" (170 mm) |

Divider system height 6", 8", 10"



Regardless of the drawer's dimensions:
We can adapt to suit your requirements

| Art. No. | Designation | Size |
|------------|---------------------|---------------------|
| 220101N-PA | Slotted rail holder | L=19 9/32" (490 mm) |
| 200099U | Aluminum rail | Drawer depth |
| 240614 | Sliding divider | L=6 11/16" (170 mm) |

Quick overview with integrated label holders for organized labeling



Easy to adjust









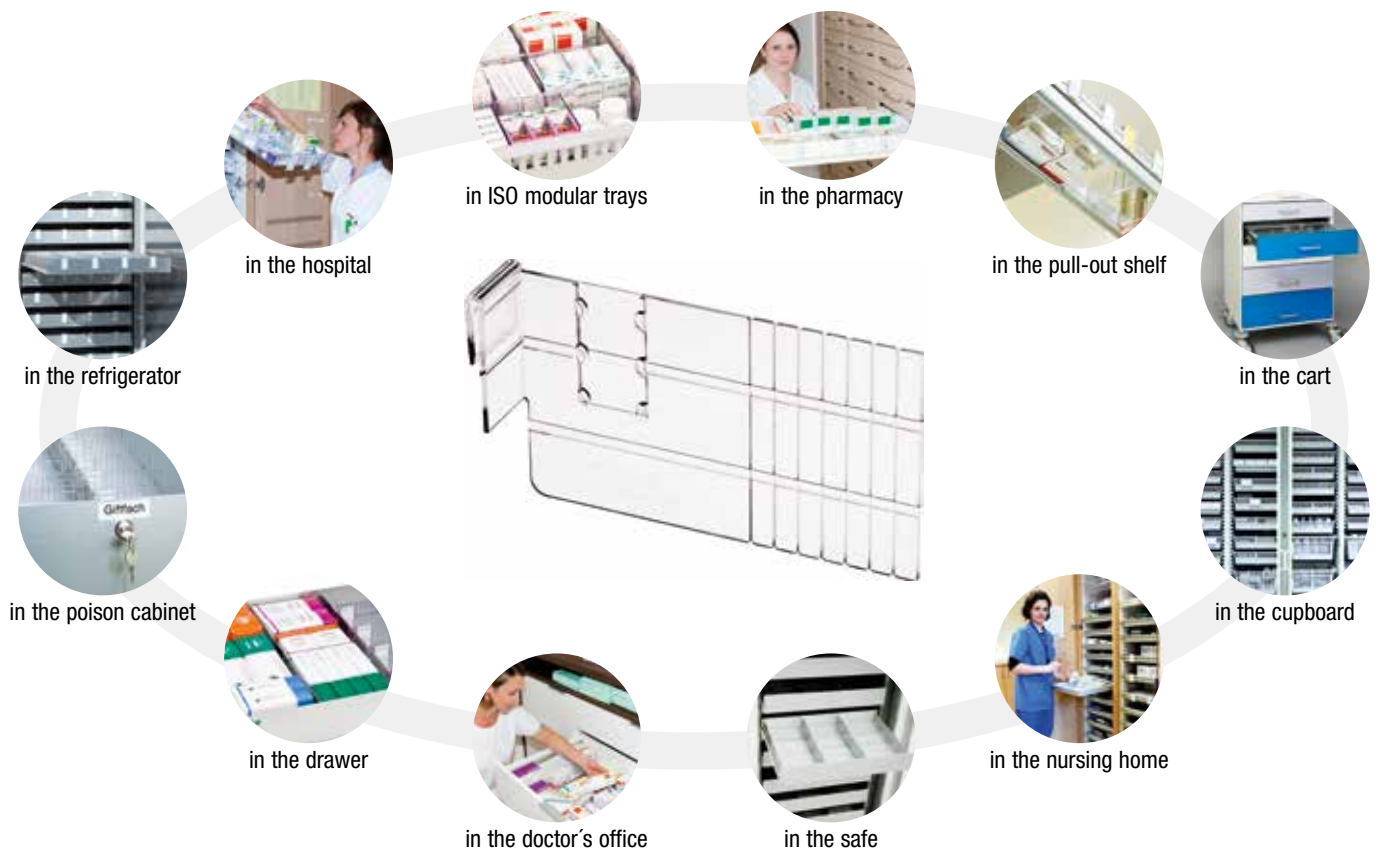



Divider, clips and rails

parts at a glance





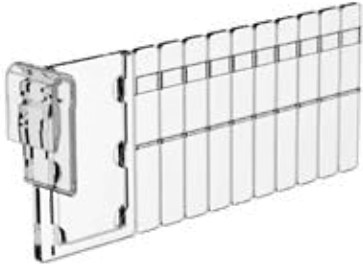

| Art. No. | Designation | Size | | |
|--|---|----------------------|---|---|
| Clips | | | | |
| 240501 | T-Clip 35/35 | |  | |
| 240503 | L-Clip 20/35 narrow, left | | | |
| 240504 | L-Clip 20/35 narrow, right | | | |
| 240506 | L-Clip 45/55 wide, left, closed upside | | | |
| 240507 | L-Clip 45/55 wide, left, open upside | | | |
| 240508 | L-Clip 45/55 wide, right, closed upside | | | |
| 240509 | L-Clip 45/55 wide, right, open upside | | | |
| Rails 1 3/8" cut to custom length | | | | |
| 200103U | Aluminum rail 35/3 | | |  |
| 210144U | Plastic rail transparent 35/3 | | | |
| 210156 | Plastic rail transparent 35/3 | L=20 7/8" (530 mm) | | |
| Dividers 1 3/8" with 2 label holders | | | | |
| 240157 | Sliding divider LH 35/3 | L=1 9/16" (40 mm)* |  | |
| 240163 | Sliding divider LH 35/3 | L=2" (50 mm)* | | |
| 240177 | Sliding divider LH 35/3 | L=2 3/8" (60 mm)* | | |
| 240178 | Sliding divider LH 35/3 | L=2 3/4" (70 mm)* | | |
| 240179 | Sliding divider LH 35/3 | L=3 1/8" (80 mm)* | | |
| 240180 | Sliding divider LH 35/3 | L=3 9/16" (90 mm)* | | |
| 240181 | Sliding divider LH 35/3 | L=3 15/16" (100 mm)* | | |
| 240182 | Sliding divider LH 35/3 | L=4 5/16" (110 mm)* | | |
| 240159 | Sliding divider LH 35/3 | L=4 3/4" (120 mm) | | |
| Dividers 1 3/8" w/o label holder | | | | |
| 240155 | Sliding divider 35/3 | L=1 9/16" (40 mm)* |  | |
| 240156 | Sliding divider 35/3 | L=2" (50 mm)* | | |
| 240166 | Sliding divider 35/3 | L=2 3/8" (60 mm)* | | |
| 240167 | Sliding divider 35/3 | L=2 3/4" (70 mm)* | | |
| 240168 | Sliding divider 35/3 | L=3 1/8" (80 mm)* | | |
| 240169 | Sliding divider 35/3 | L=3 9/16" (90 mm)* | | |
| 240170 | Sliding divider 35/3 | L=3 15/16" (100 mm)* | | |
| 240171 | Sliding divider 35/3 | L=4 5/16" (110 mm)* | | |
| 240158 | Sliding divider 35/3 | L=4 3/4" (120 mm) | | |
| 240172 | Sliding divider 35/3 | L=5 1/8" (130 mm)* | | |
| 240160 | Sliding divider 35/3 | L=5 1/2" (140 mm) | | |
| 240173 | Sliding divider 35/3 | L=5 7/8" (150 mm)* | | |
| 240174 | Sliding divider 35/3 | L=6 5/16" (160 mm) | | |
| 240161 | Sliding divider 35/3 | L=6 11/16" (170 mm) | | |
| 240175 | Sliding divider 35/3 | L=7 1/16" (180 mm)* | | |
| 240176 | Sliding divider 35/3 | L=7 1/2" (190 mm)* | | |
| 240162 | Sliding divider 35/3 | L=7 7/8" (200 mm) | | |
| Long dividers 1 3/8" w/o label holder | | | | |
| 240151 | Sliding Divider 35/3 | L=11 3/4" (300 mm) |  | |
| 240152 | Sliding Divider 35/3 | L=15 3/4" (400 mm) | | |
| 240150 | Sliding Divider 35/3 | L=19 13/32" (493 mm) | | |
| 240153 | Sliding Divider 35/3 | L=19 11/16" (500 mm) | | |
| 240154 | Sliding Divider 35/3 | L=23 5/8" (600 mm) | | |





*tabs broken off of longer divider **custom divider

| Art. No. | Designation | Size | |
|---|---|---------------------------------|---|
| Rails 2 5/16" cut to custom length | | | |
| 200101U | Aluminum rail 55/3 | |  |
| 210143U | Plastic transparent rail 55/3 | | |
| 210145 | Plastic rail transparent 55/3, L=23 5/8" (600 mm) | | |
| Dividers 2 5/16" with label holder | | | |
| 240117 | Sliding divider LH 55/3 | L=1 9/16" (40 mm)* |  |
| 240118 | Sliding divider LH 55/3 | L=2" (50 mm)* | |
| 240089 | Sliding divider LH 55/3 | L=2 3/8" (60 mm)* | |
| 240090 | Sliding divider LH 55/3 | L=2 3/4" (70 mm)* | |
| 240080 | Sliding divider LH 55/3 | L= 3" (77 mm) | |
| 240091 | Sliding divider LH 55/3 | L=3 1/8" (80 mm)* | |
| 240092 | Sliding divider LH 55/3 | L=3 9/16" (90 mm)* | |
| 240093 | Sliding divider LH 55/3 | L=3 15/16" (100 mm)* | |
| 240081 | Sliding divider LH 55/3 | L=4 5/16" (110 mm)* | |
| 240082 | Sliding divider LH 55/3 | L=4 3/4" (120 mm) | |
| 240083 | Sliding divider LH 55/3 | L=5 1/8" (130 mm) | |
| 240084 | Sliding divider LH 55/3 | L=5 1/2" (140 mm)* | |
| 240085 | Sliding divider LH 55/3 | L=5 7/8" (150 mm) | |
| 240086 | Sliding divider LH 55/3 | L=6 5/16" (160 mm)* | |
| 240087 | Sliding divider LH 55/3 | L=6 11/16" (170 mm) | |
| 240094 | Sliding divider LH 55/3 | L=7 1/16" (180 mm)* | |
| 240095 | Sliding divider LH 55/3 | L=7 1/2" (190 mm)* | |
| 240088 | Sliding divider LH 55/3 | L=7 7/8" (200 mm) | |
| Dividers 2 5/16" w/o label holder | | | |
| 240109 | Sliding divider 55/3 | L=1 9/16" (40 mm)* |  |
| 240113 | Sliding divider 55/3 | L=2" (50 mm)* | |
| 240071 | Sliding divider 55/3 | L=2 3/8" (60 mm)* | |
| 240072 | Sliding divider 55/3 | L=2 3/4" (70 mm)* | |
| 240070 | Sliding divider 55/3 | L= 3" (77 mm) | |
| 240073 | Sliding divider 55/3 | L=3 1/8" (80 mm)* | |
| 240074 | Sliding divider 55/3 | L=3 9/16" (90 mm)* | |
| 240075 | Sliding divider 55/3 | L=3 15/16" (100 mm)* | |
| 240076 | Sliding divider 55/3 | L=4 5/16" (110 mm)* | |
| 240078 | Sliding divider 55/3 | L=4 3/4" (120 mm)* | |
| 240079 | Sliding divider 55/3 | L=5 1/8" (130 mm)* | |
| 240106 | Sliding divider 55/3 | L=5 1/2" (140 mm)* | |
| 240107 | Sliding divider 55/3 | L=5 7/8" (150 mm)* | |
| 240108 | Sliding divider 55/3 | L=6 5/16" (160 mm)* | |
| 240077 | Sliding divider 55/3 | L=6 11/16" (170 mm) | |
| 240114 | Sliding divider 55/3 | L=7 1/16" (180 mm)* | |
| 240115 | Sliding divider 55/3 | L=7 1/2" (190 mm)* | |
| 240116 | Sliding divider 55/3 | L=7 7/8" (200 mm) | |
| Long dividers 2 5/16" with narrow clip | | | |
| 240123 | Sliding divider 55/3 | L=23 5/8" (600 mm), narrow clip |  |



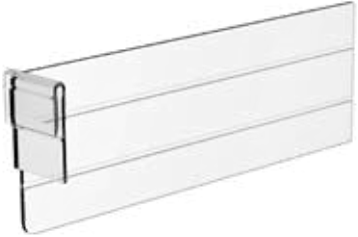

*tabs broken off of longer divider **custom divider

| Art. No. | Designation | Size | |
|--------------------------------------|--|------------------------------|---|
| Long dividers 2 5/16" with wide clip | | | |
| 240133 | Sliding divider 55/3 | L=14 3/8" (366 mm) with hole |  |
| 240132 | Sliding divider 55/3 | L=14 3/4" (374 mm) | |
| 240131 | Sliding divider 55/3 | L=15 1/2" (393 mm) | |
| 240137 | Sliding divider 55/3 | L=15 3/4" (400 mm) | |
| 240138 | Sliding divider 55/3 | L=19 11/16" (500 mm) | |
| 240139 | Sliding divider 55/3 | L=23 5/8" (600 mm) | |
| Rails 4" cut to custom length | | | |
| 200100U | Aluminum rail 100/3 | |  |
| 210297U | Plastic transparent rail 100/3 | | |
| 210158 | Plastic rail transparent 100/3, L=23 5/8" (600 mm) | | |
| Dividers 4" with label holder | | | |
| 240792 | Sliding divider LH 100/3 | L=2 3/8" (60 mm)* |  |
| 240794 | Sliding divider LH 100/3 | L=2 3/4" (70 mm)* | |
| 240796 | Sliding divider LH 100/3 | L=3 1/8" (80 mm)* | |
| 240798 | Sliding divider LH 100/3 | L=3 9/16" (90 mm)* | |
| 240801 | Sliding divider LH 100/3 | L=3 15/16" (100 mm)* | |
| 240807 | Sliding divider LH 100/3 | L=4 5/16" (110 mm)* | |
| 240811 | Sliding divider LH 100/3 | L=4 3/4" (120 mm)* | |
| 240836 | Sliding divider LH 100/3 | L=5 1/8" (130 mm)* | |
| 240837 | Sliding divider LH 100/3 | L=5 1/2" (140 mm)* | |
| 240838 | Sliding divider LH 100/3 | L=5 7/8" (150 mm)* | |
| 240839 | Sliding divider LH 100/3 | L=6 5/16" (160 mm)* | |
| 240821 | Sliding divider LH 100/3 | L=6 11/16" (170 mm) | |
| 240808 | Sliding divider LH 100/3 | L=7 1/16" (180 mm)* | |
| 240829 | Sliding divider LH 100/3 | L=7 1/2" (190 mm)* | |
| 240809 | Sliding divider LH 100/3 | L=7 7/8" (200 mm)* | |
| 240851 | Sliding divider LH 100/3 | L= 11 3/4" (300 mm) | |
| Dividers 4" w/o label holder | | | |
| 240793 | Sliding divider 100/3 | L=2 3/8" (60 mm)* |  |
| 240795 | Sliding divider 100/3 | L=2 3/4" (70 mm)* | |
| 240797 | Sliding divider 100/3 | L=3 1/8" (80 mm)* | |
| 240799 | Sliding divider 100/3 | L=3 9/16" (90 mm)* | |
| 240800 | Sliding divider 100/3 | L=3 15/16" (100 mm)* | |
| 240806 | Sliding divider 100/3 | L=4 5/16" (110 mm)* | |
| 240810 | Sliding divider 100/3 | L=4 3/4" (120 mm)* | |
| 240816 | Sliding divider 100/3 | L=5 1/8" (130 mm)* | |
| 240817 | Sliding divider 100/3 | L=5 1/2" (140 mm)* | |
| 240818 | Sliding divider 100/3 | L=5 7/8" (150 mm)* | |
| 240819 | Sliding divider 100/3 | L=6 5/16" (160 mm)* | |
| 240820 | Sliding divider 100/3 | L=6 11/16" (170 mm) | |
| 240824 | Sliding divider 100/3 | L=7 1/16" (180 mm)* | |
| 240828 | Sliding divider 100/3 | L=7 1/2" (190 mm)* | |
| 240834 | Sliding divider 100/3 | L=7 7/8" (200 mm)* | |
| 240850 | Sliding divider 100/3 | L= 11 3/4" (300 mm) | |

*tabs broken off of longer divider **custom divider

| Art. No. | Designation | Size | |
|---------------------------------|--------------------------------|----------------------|---|
| Long dividers 4" with wide clip | | | |
| 240857 | Sliding divider 100/3 | L=11 3/4" (300 mm) |  |
| 240854 | Sliding divider 100/3 | L=15 3/4" (400 mm) | |
| 240858 | Sliding divider 100/3 | L=17 5/8" (447 mm) | |
| 240855 | Sliding divider 100/3 | L=19 11/16" (500 mm) | |
| 240856 | Sliding divider 100/3 | L=23 5/8" (600 mm) | |
| Rails 5" cut to custom length | | | |
| 200098U | Aluminum rail 125/3 | |  |
| 210293U | Plastic transparent rail 125/3 | | |
| Dividers 5" w/o label holder | | | |
| 240868 | Sliding divider 125/3 | L=2 3/8" (60 mm)* |  |
| 240869 | Sliding divider 125/3 | L=2 3/4" (70 mm)* | |
| 240871 | Sliding divider 125/3 | L=3 1/8" (80 mm)* | |
| 240872 | Sliding divider 125/3 | L=3 9/16" (90 mm)* | |
| 240873 | Sliding divider 125/3 | L=3 15/16" (100 mm)* | |
| 240874 | Sliding divider 125/3 | L=4 5/16" (110 mm)* | |
| 240875 | Sliding divider 125/3 | L=4 3/4" (120 mm)* | |
| 240870 | Sliding divider 125/3 | L=5" (127 mm) | |
| 240876 | Sliding divider 125/3 | L=5 1/8" (130 mm)* | |
| 240877 | Sliding divider 125/3 | L=5 1/2" (140 mm)* | |
| 240878 | Sliding divider 125/3 | L=5 7/8" (150 mm)* | |
| 240879 | Sliding divider 125/3 | L=6 5/16" (160 mm)* | |
| 240880 | Sliding divider 125/3 | L=6 11/16" (170 mm) | |
| 240881 | Sliding divider CD 125/3 | L=7 1/16" (180 mm)** | |
| 240882 | Sliding divider CD 125/3 | L=7 1/2" (190 mm)** | |
| 240625 | Sliding divider CD 125/3 | L=7 7/8" (200 mm)** | |
| Long dividers 5" with wide clip | | | |
| 240865 | Sliding divider 125/3 | L=17 5/8" (447 mm) |  |
| 240864 | Sliding divider 125/3 | L=23 5/8" (600 mm) | |
| Rails 6" cut to custom length | | | |
| 200099U | Aluminum rail 150/3 | |  |
| 210139U | Plastic transparent rail 150/3 | | |

*tabs broken off of longer divider **custom divider

| Art. No. | Designation | Size | |
|--|---|-----------------------|---|
| Dividers 6" w/o label holder | | | |
| 240601 | Sliding divider CD 150/3 | L=2 3/8" (60 mm)** |  |
| 240602 | Sliding divider CD 150/3 | L=2 3/4" (70 mm)** | |
| 240603 | Sliding divider CD 150/3 | L=3 1/8" (80 mm)** | |
| 240617 | Sliding divider CD 150/3 | L=3 9/16" (90 mm)** | |
| 240604 | Sliding divider CD 150/3 | L=3 15/16" (100 mm)** | |
| 240605 | Sliding divider CD 150/3 | L=4 5/16" (110 mm)** | |
| 240606 | Sliding divider CD 150/3 | L=4 3/4" (120 mm)** | |
| 240607 | Sliding divider CD 150/3 | L=5 1/8" (130 mm)** | |
| 240618 | Sliding divider CD 150/3 | L=5 1/2" (140 mm)** | |
| 240611 | Sliding divider CD 150/3 | L=5 7/8" (150 mm)** | |
| 240608 | Sliding divider CD 150/3 | L=6 5/16" (160 mm)** | |
| 240614 | Sliding divider CD 150/3 | L=6 11/16" (170 mm)** | |
| 240609 | Sliding divider CD 150/3 | L=7 1/16" (180 mm)** | |
| 240619 | Sliding divider CD 150/3 | L=7 1/2" (190 mm)** | |
| 240621 | Sliding divider CD 150/3 | L=7 7/8" (200 mm)** | |
| Rails 8" cut to custom length | | | |
| 210140U | Plastic transparent rail 200/3 | |  |
| Dividers 8" w/o cardholders | | | |
| 240593 | Sliding divider CD 200/3 | L=2 3/8" (60 mm)** |  |
| 240594 | Sliding divider CD 200/3 | L=2 3/4" (70 mm)** | |
| 240595 | Sliding divider CD 200/3 | L=3 1/8" (80 mm)** | |
| 240596 | Sliding divider CD 200/3 | L=3 9/16" (90 mm)** | |
| 240597 | Sliding divider CD 200/3 | L=3 15/16" (100 mm)** | |
| 240598 | Sliding divider CD 200/3 | L=4 5/16" (110 mm)** | |
| 240599 | Sliding divider CD 200/3 | L=4 3/4" (120 mm)** | |
| 240600 | Sliding divider CD 200/3 | L=5 1/8" (130 mm)** | |
| 240626 | Sliding divider CD 200/3 | L=5 1/2" (140 mm)** | |
| 240612 | Sliding divider CD 200/3 | L=5 7/8" (150 mm)** | |
| 240627 | Sliding divider CD 200/3 | L=6 5/16" (160 mm)** | |
| 240615 | Sliding divider CD 200/3 | L=6 11/16" (170 mm)** | |
| 240628 | Sliding divider CD 200/3 | L=7 1/16" (180 mm)** | |
| 240629 | Sliding divider CD 200/3 | L=7 1/2" (190 mm)** | |
| 240622 | Sliding divider CD 200/3 | L=7 7/8" (200 mm)** | |
| Long dividers 8" with wide clip | | | |
| 240890 | Sliding divider 200/3, L=23 5/8" (600 mm) | |  |

*tabs broken off of longer divider **custom divider

H+H FLEXSHELF®

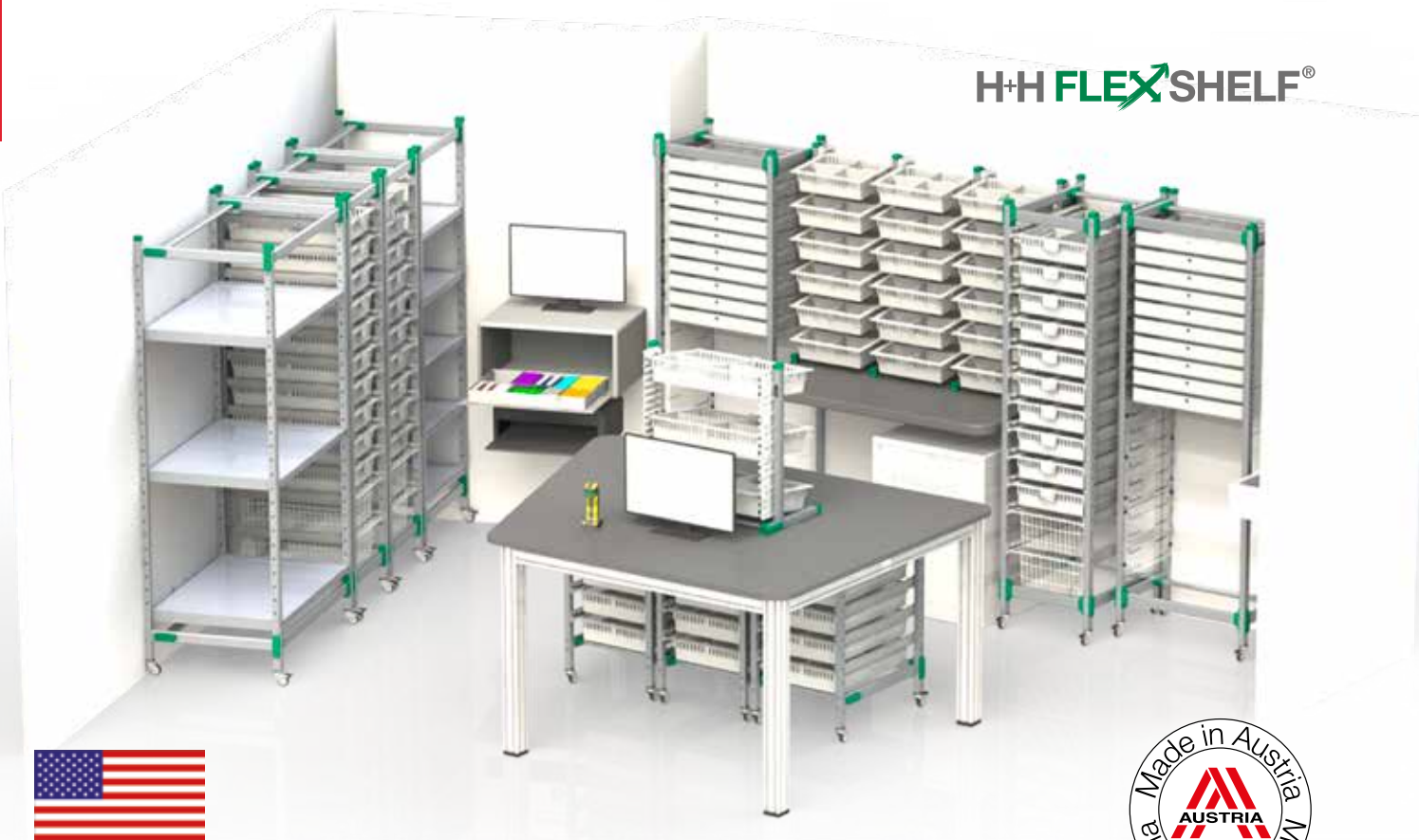

Assembled USA



H+H FlexShelf

for storage and work

- | Modular storage system
- | For meds, overstock, etc.
- | Custom design
- | Frame made of anodized aluminum
- | 880 lbs. loading capacity per column
- | Adjustable feet or wheels with brakes
- | Combinable with ISO modular trays
- | Optional floor and wall fixations

Expand as desired,
theoretically infinite



Heights and Sizes

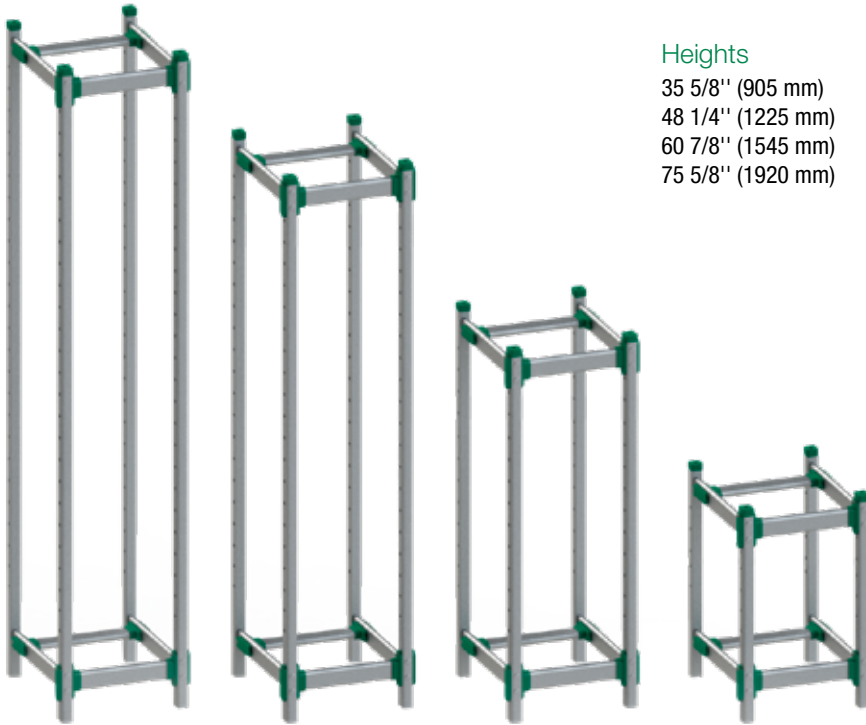

Heights

35 5/8" (905 mm)
 48 1/4" (1225 mm)
 60 7/8" (1545 mm)
 75 5/8" (1920 mm)

Sizes

11 3/4 x 15 3/4" (300 x 400 mm)
 15 3/4 x 15 3/4" (400 x 400 mm)
 23 5/8 x 15 3/4" (600 x 400 mm)
 35 3/8 x 15 3/4" (900 x 400 mm)
 47 1/4 x 15 3/4" (1200 x 400 mm)
 59 x 15 3/4" (1500 x 400 mm)
 11 3/4 x 23 5/8" (300 x 600 mm)
 15 3/4 x 23 5/8" (400 x 600 mm)
 23 5/8 x 23 5/8" (600 x 600 mm)
 35 3/8 x 23 5/8" (900 x 600 mm)
 47 1/4 x 23 5/8" (1200 x 600 mm)
 59 x 23 5/8" (1500 x 600 mm)

Design your own storage system

Let us transform your work space

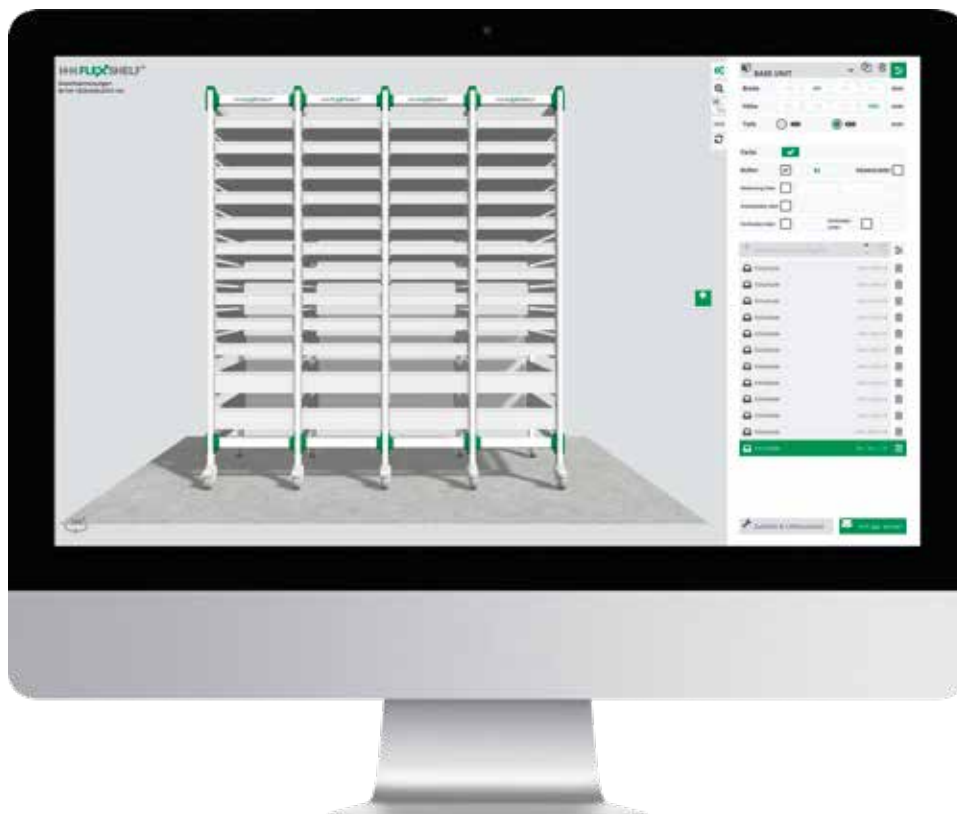

Discover our
online 3D planner





Storage shelves

- | Optimal storage and flexible expansion
- | Clear and space saving storage
- | With ISO modular trays for medicines, vials, and small parts
- | With pull-out shelves and drawers
- | With shelves for bulk goods



Workstations

- | Storage and preparation
- | Optimal use of space and time
- | Adaptable to any environment
- | Preparation of medicines
- | Scanning of products
- | Documentation



Mobile units

- | Transport of ISO modular trays and H+H exchange trays
- | Sturdy swivel casters
- | Comfortable handle
- | Robust and jointless worktops
- | Combinations of trays, shelves, and drawers

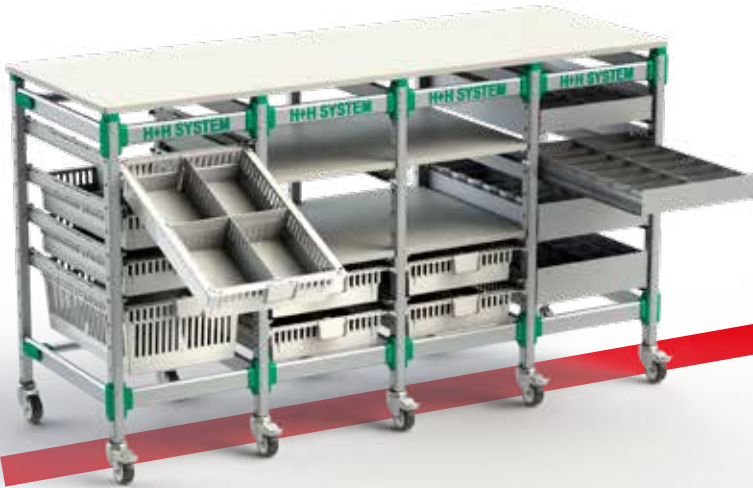

H+H FlexShelf MHD

The mobile high density storage system

- | Lightweight construction – stable aluminum
- | Pass-through feature – workflow from both sides
- | Add on to existing FlexShelf or individual solution
- | Only 1 aisle necessary for many shelves
- | All mechanical – no need for electricity
- | No floor fixation

Maximum flexibility and great space savings – fully accessible without floor rail

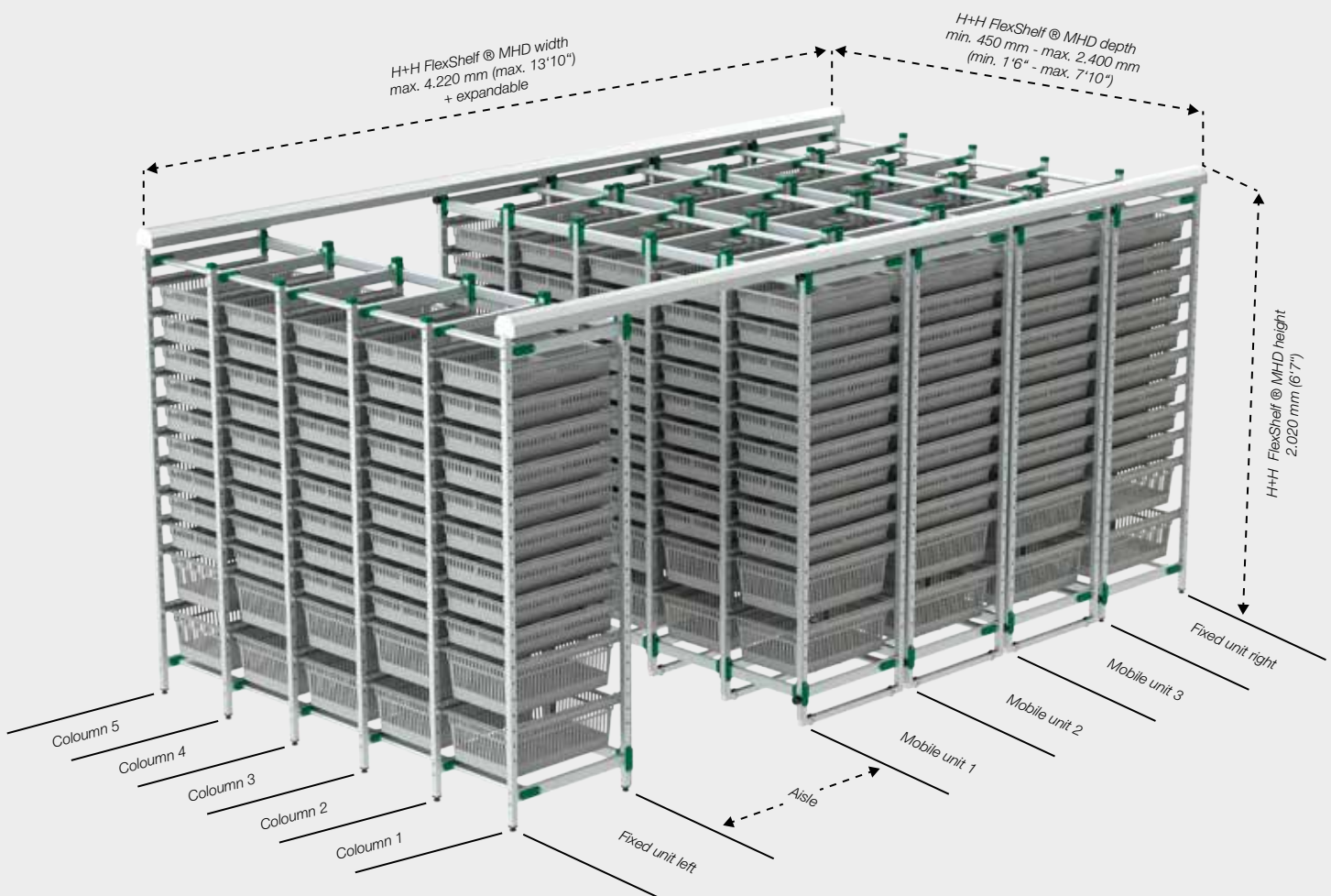



Modular tray system in ISO

- | Standardized ISO system 23 5/8" x 15 3/4"
(600 x 400 mm)
- | Patented flexible divider system
- | Perfect overview
- | Transparent and gray modular trays
- | Different heights
- | Save up to 30% space

The H+H SYSTEM
modular tray system –
a flexible innovation on the
ISO modular tray market



H+H FLEXMODUL®

- Tray and basket in one - the perfect fusion to gain the advantages of both
- Unique solution for the storage of medicines and consumer goods

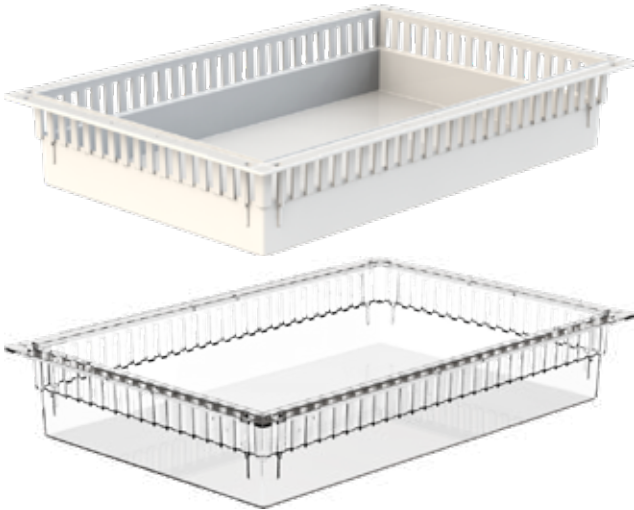

| Art. No. | Size (W x D x H) | Color | Long dividers Art. No. | Short dividers Art. No. | Sliding dividers Art. No. |
|----------|----------------------|-------|---------------------------|----------------------------|---------------------------------|
| 7012100 | 23 5/8 x 15 3/4 x 4" | Gray | 7811204N | 7811205N | 240820 |
| 7022100 | 23 5/8 x 15 3/4 x 4" | Clear | 7811207 | 7811208 | 240820 |
| 7014100 | 11 3/4 x 15 3/4 x 4" | Gray | 7811205N | 7811206N | 240820 |
| 7024100 | 11 3/4 x 15 3/4 x 4" | Clear | 7811208 | 7811203N | 240820 |



| Art. No. | Size (W x D x H) | Color | Long dividers Art. No. | Short dividers Art. No. | Sliding dividers Art. No. |
|----------|----------------------|-------|---------------------------|----------------------------|---------------------------------|
| 7012200 | 23 5/8 x 15 3/4 x 8" | Gray | 7811304 | 7811305 | - |
| 7022200 | 23 5/8 x 15 3/4 x 8" | Clear | 7811307 | 7811308 | - |
| 7014200 | 11 3/4 x 15 3/4 x 8" | Gray | 7811305 | 7811306 | - |
| 7024200 | 11 3/4 x 15 3/4 x 8" | Clear | 7811308 | 7811303 | - |

H+H FLEXBASKET

- | Light weight
- | Ideal ventilation
- | Minimal accumulation of dust particles

H+H FlexModul®, H+H FlexBasket and H+H FlexTray

All three can be combined enabling you to benefit from the advantages of all our innovative systems



| Art. No. | Size (W x D x H) | Color | Long dividers Art. No. | Short dividers Art. No. | Sliding dividers Art. No. |
|----------|----------------------|-------|---------------------------|----------------------------|---------------------------------|
| 7015100 | 23 5/8 x 15 3/4 x 4" | Gray | 7811204N | 7811205N | 240820 |
| 7025100 | 23 5/8 x 15 3/4 x 4" | Clear | 7811207 | 7811208 | 240820 |
| 7015200 | 23 5/8 x 15 3/4 x 8" | Gray | 7811304 | 7811305 | - |
| 7025200 | 23 5/8 x 15 3/4 x 8" | Clear | 7811307 | 7811308 | - |



H+H FLEXTRAY

- | Easy to divide
- | Easy to clean

| Art. No. | Size (W x D x H) | Color | Long dividers Art. No. | Short dividers Art. No. | Sliding dividers Art. No. |
|----------|----------------------|-------|---------------------------|----------------------------|---------------------------------|
| 7011050 | 23 5/8 x 15 3/4 x 2" | Gray | 7810104 | 7810105 | 241302 |
| 7021050 | 23 5/8 x 15 3/4 x 2" | Clear | 7810107 | 7810108 | 241302 |
| 7011100 | 23 5/8 x 15 3/4 x 4" | Gray | 7811204N | 7811205N | 240820 |
| 7011200 | 23 5/8 x 15 3/4 x 8" | Gray | 7811304 | 7811305 | - |



| Art. No. | Size (W x D x H) | Color | Long dividers Art. No. | Short dividers Art. No. | Sliding dividers Art. No. |
|----------|----------------------|-------|---------------------------|----------------------------|---------------------------------|
| 7014050 | 11 3/4 x 15 3/4 x 2" | Gray | 7810105 | 7810109 | 241302 |
| 7024050 | 11 3/4 x 15 3/4 x 2" | Clear | 7810108 | 7810109 | 241302 |





Dividers for ISO modular trays

- ISO dividers: adjustable every 1 or 2 cm, strong hold thanks to the ClipOn effect (fixed connection of modular tray / basket / tray and dividers)
- All space is utilized effectively
- Integrated label holders for space saving labeling
- Sliding dividers - continuously adjustable, so the divider can be pushed directly up to the product

Space savings of up to 30% thanks to the dividers of H+H SYSTEM



With ISO dividers



With H+H sliding dividers



ISO divider ABS gray

Strong hold thanks to the fixed connection between ISO modular trays and dividers (ClipOn effect)

| Art. No. | Size (W x H) | For FlexModul / FlexBasket / FlexTray |
|----------|--------------|---------------------------------------|
| 7810105 | 15 3/4 x 2" | height 2" (50 mm) |
| 7810104 | 23 5/8 x 2" | height 2" (50 mm) |
| 7811206N | 11 3/4 x 4" | height 4" (100 mm) |
| 7811205N | 15 3/4 x 4" | height 4" (100 mm) |
| 7811204N | 23 5/8 x 4" | height 4" (100 mm) |
| 7811306 | 11 3/4 x 8" | height 8" (200 mm) |
| 7811305 | 15 3/4 x 8" | height 8" (200 mm) |
| 7811304 | 23 5/8 x 8" | height 8" (200 mm) |

ISO dividers transparent

Strong hold thanks to the fixed connection between ISO modular trays and dividers (ClipOn effect)

| Art. No. | Size (W x H) | For FlexModul / FlexBasket / FlexTray |
|----------|--------------|---------------------------------------|
| 7810109 | 11 3/4 x 2" | height 2" (50 mm) |
| 7810108 | 15 3/4 x 2" | height 2" (50 mm) |
| 7810107 | 23 5/8 x 2" | height 2" (50 mm) |
| 7811203N | 11 3/4 x 4" | height 4" (100 mm) |
| 7811208 | 15 3/4 x 4" | height 4" (100 mm) |
| 7811207 | 23 5/8 x 4" | height 4" (100 mm) |
| 7811303 | 11 3/4 x 8" | height 8" (200 mm) |
| 7811308 | 15 3/4 x 8" | height 8" (200 mm) |
| 7811307 | 23 5/8 x 8" | height 8" (200 mm) |



Infinite variety of subdivision options

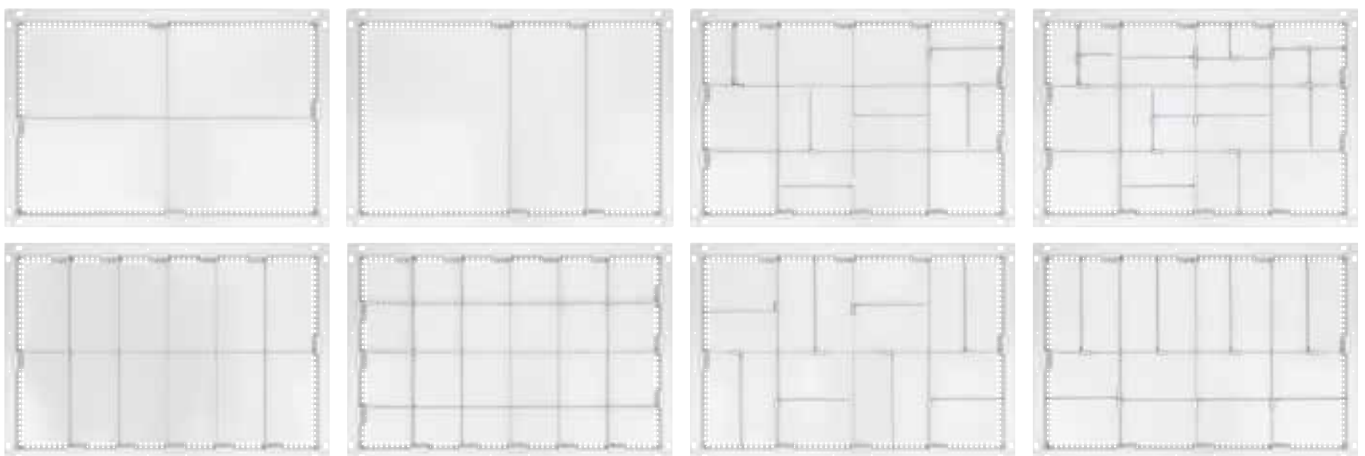



241302

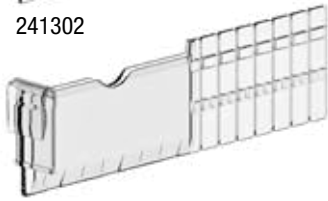

241301



240820



240821

Flexible sliding divider

- For any FlexModul / FlexBasket / FlexTray
- Transparent dividers for an optimal overview
- The flexible solution in combination with cross recess dividers
- Dividers are easily adjustable to the size of the stored product
- With integrated label holder

| Art. No. | Size (W x H) |
|----------|-------------------|
| 241302 | 6 11/16" x 1 3/4" |
| 241301 | 6 11/16" x 1 3/4" |
| 240821 | 6 11/16" x 4" |
| 240820 | 6 11/16" L x 4" |

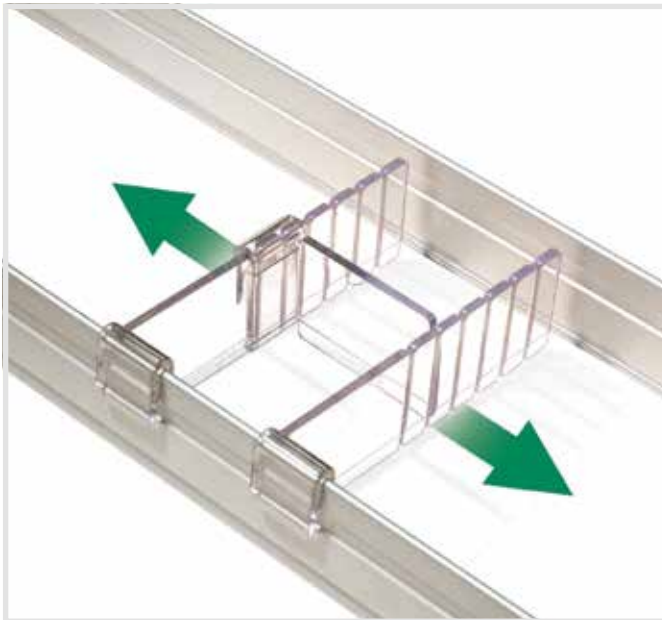

Our sliding dividers can be used anywhere
and help you save up to 30% space



Accessories for ISO modular trays



ISO lid plastic gray

- | Suitable for ISO modular tray system
- | With holes for seals

| Art. No. | Size (W x D x H) |
|----------|-------------------|
| 7940502 | 23 5/8 x 15 3/4" |
| 7940501 | 11 3/4" x 15 3/4" |

Tearaway seals long for lids

- | In different colors
- | Serial numbered for tracking
- | Quantity per pack: 100 pcs

| Art. No. | Description |
|----------|-----------------|
| 840021B | Blue, 8" long |
| 840021G | Green, 8" long |
| 840021R | Red, 8" long |
| 840021Y | Yellow, 8" long |

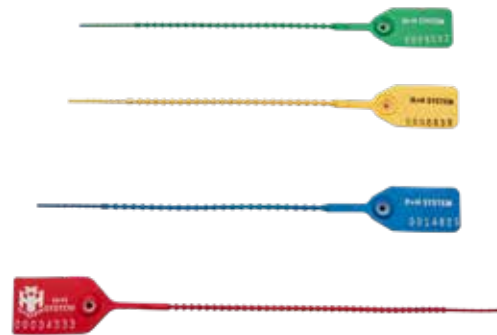

Tearaway seals square for lids

- | In different colors
- | Serial numbered for tracking
- | Quantity per pack: 100 pcs

| Art. No. | Description |
|----------|-------------|
| 840022G | Green |
| 840022R | Red |
| 840022Y | Yellow |

Simple and effective
**The ISO lids can be sealed,
 thus ensuring
 maximum security**

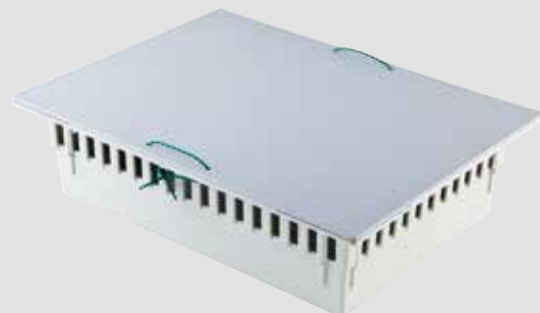

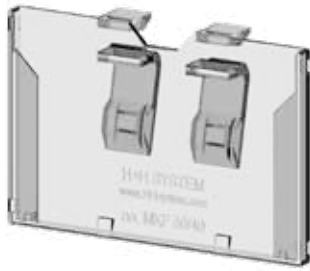

Label holder 60/40 with clip and hooks

- | Suitable for label K100185 (2 3/8 x 1 9/16")
- | Vertical and horizontal clip function
- | Optional transparent cover for label

| Art. No. | Designation |
|----------|------------------------|
| 100059 | transparent |
| 100073 | Cover for label holder |

Label holder 40/60 with clip and hooks

- | Suitable for label K100185 (1 9/16 x 2 3/8")
- | Vertical and horizontal clip function
- | For modular trays, dividers, etc.

| Art. No. | Designation |
|----------|-------------|
| 100060 | transparent |



Label holder 40/54 with clip and hooks

- | Suitable for label 100188 (1 9/16 x 2 1/8")
- | Vertical and horizontal clip function
- | For modular trays, dividers, etc.

| Art. No. | Designation |
|----------|-------------|
| 100067 | transparent |

Label holder 85/54 with clip and hooks

- | Suitable for label K100187 (3 3/8 x 2 1/8")
- | Vertical and horizontal clip function
- | Available in transparent and various colors

| Art. No. | Designation |
|-----------|-------------|
| 100072 | transparent |
| 100072-bl | blue |
| 100072-gr | green |
| 100072-or | orange |
| 100072-rt | red |





Labeling rail, adhesive

- | Transparent
- | With adhesive tape

| Art. No. | Size (W x H) |
|----------|----------------------------|
| 7972350 | 13 3/4" x 1" (350 x 25 mm) |

Labeling rail

- | For ISO modular trays

| Art. No. | Size (W x H) |
|----------|------------------------------|
| 7971060 | 2 3/8 x 1 9/16" (60 x 40 mm) |





Label 1 9/16 x 2 1/8"

- | For label holder 100067
- | Plastic white, blank
- | Thickness 1/64" (0,5 mm)

| Art. No. | Description |
|----------|------------------------------|
| 100188 | 1 9/16 x 2 1/8" (40 x 54 mm) |

Label 2 3/8 x 1 9/16"

- | For label holder 100059 and 100060
- | Plastic white, blank
- | Thickness 1/64" (0,5 mm)

| Art. No. | Description |
|----------|---------------------|
| K100185 | 60 x 40 mm – 0,5 mm |

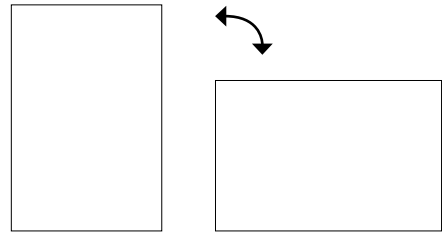

Label 3 3/8 x 2 1/8"

- | For label holder 100072 with clip or 100077 with adhesive tape
- | Plastic white, blank
- | Thickness 1/64" (0,5 mm)

| Art. No. | Description |
|----------|-----------------------------|
| K100187 | 3 3/8 x 2 1/8" (85 x 54 mm) |







Full extension runners for ISO modular trays and equipment

- | Load capacity up to 154 lbs
- | Adjustable in height every 9/16" (14 mm)
- | For all H+H ISO modular trays
- | Easy exchange of modular trays
- | Fits in pilaster without tools
- | Available with SoftClose

Perfect sliding thanks
to full extension - ideal
for medium and lower
heights



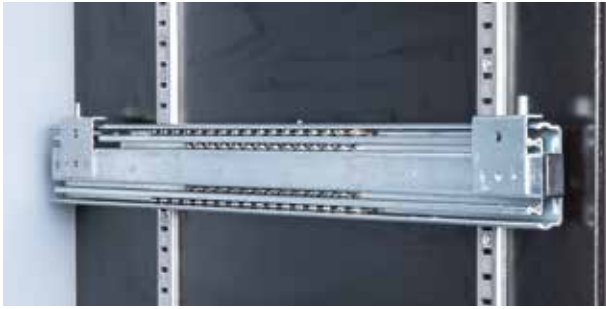

ISO full extension runner

- | Galvanized steel
- | Load capacity up to 154 lbs
- | Easily moved to a new height requirement
- | Pairs with all H+H ISO modular trays

| Art. No. | Length |
|----------|------------------|
| 7930101 | 23 5/8" (600 mm) |
| 7930102 | 15 3/4" (400 mm) |



ISO pilaster

- | For cabinets
- | Stainless steel
- | For full extension runners

| Art. No. | Length |
|----------|-------------------|
| 7930907 | 74 1/2" (1890 mm) |
| 7930906 | 37 1/2" (952 mm) |
| 7930905 | 24 3/4" (630 mm) |





Side panels for ISO modular trays and equipment

- | Cost-effective solution
- | Easy exchange of modular trays
- | For all H+H ISO modular trays
- | Stop function prevents the modular trays from falling out

Optimal overview in the cabinet, easy to exchange and light weight

- 1 Straight stopping function
- 2 30° hinged stopping function
- 3 Pass-through feature
- 4 Optional roller wheels

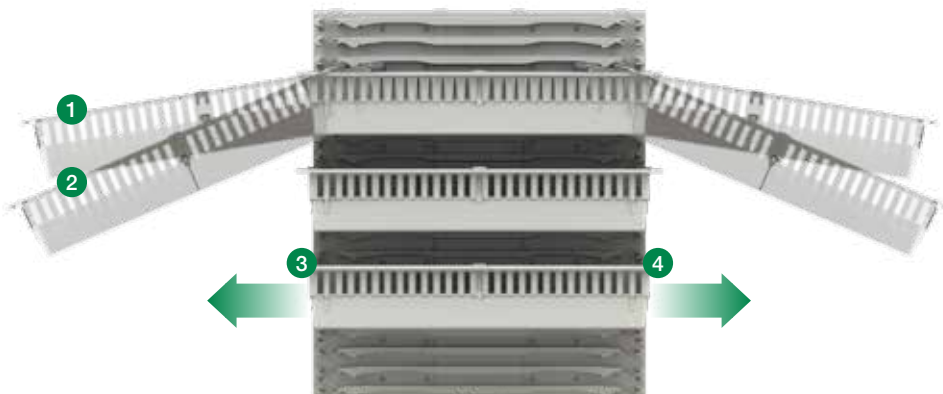

Modular trays slide easily on our roller wheels

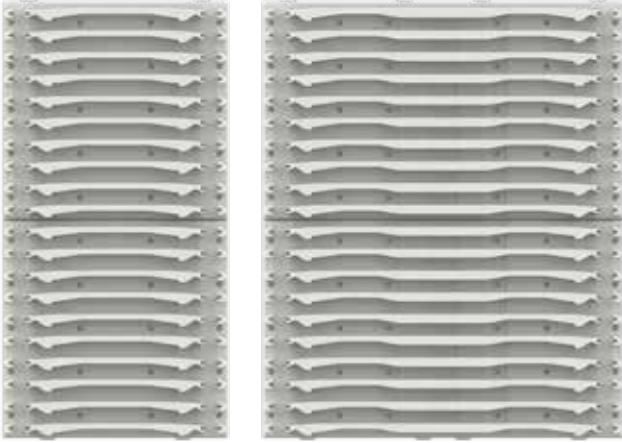

ISO side panel 4in1, 15 3/4" (400 mm) and 23 5/8" (600 mm)

- Plastic ABS
- Usable from both sides
- Usable as left or right panel

| Art. No. | Description | Size (W x H) |
|----------|--------------------|----------------------------------|
| 7900032 | Side panel 15 3/4" | 13 x 25 3/16" (330 x 640 mm) |
| 7900033 | Side panel 23 5/8" | 20 3/4 x 25 3/16" (530 x 640 mm) |

ISO side panel 3in1, 11 3/4" (300 mm), left and right

- Plastic ABS gray

| Art. No. | Side | Size (W x H) |
|----------|-------|------------------------------------|
| 7900030 | left | 10 11/32 x 25 3/16" (263 x 640 mm) |
| 7900031 | right | 10 11/32 x 25 3/16" (263 x 640 mm) |



ISO stopper



- Prevents the modular trays from falling out

| Art. No. | Description |
|----------|---------------------|
| 7910201N | ISO stopper 3 short |

ISO roller wheel



- For perfect sliding in the side panel

| Art. No. | Description |
|----------|---------------|
| 7900040 | Plastic green |

ISO shelf aluminum composite

- To put into side panels
- Suitable for ISO lengthwise and crosswise

| Art. No. | Designation | Size (W x D x H) |
|----------|-------------|---|
| 7960402 | white | 11 3/4 x 23 5/8 x 1/4" (300 x 600 x 6 mm) |
| 7960403 | white | 15 3/4 x 23 5/8 x 1/4" (400 x 600 x 6 mm) |
| 7960404 | white | 23 3/4 x 23 5/8 x 1/4" (600 x 600 x 6 mm) |
| 7960405 | white | 11 3/4 x 15 3/4 x 1/4" (300 x 400 x 6 mm) |



Stable and reliable
**All shelves fit perfectly
 into the side panels**







Storage examples

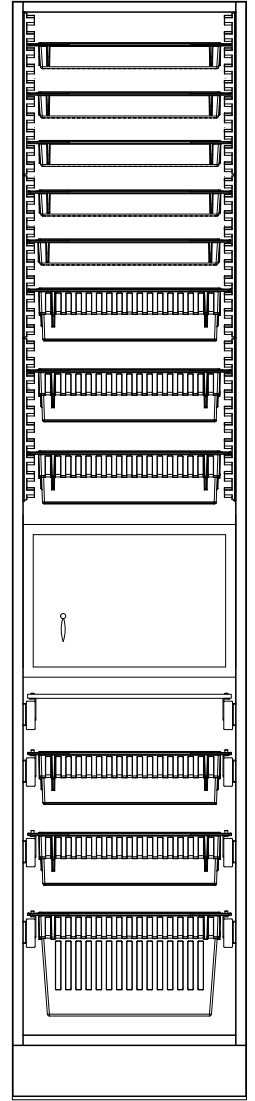
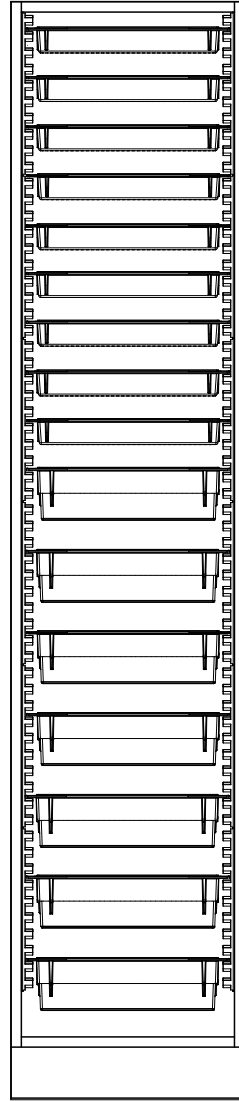
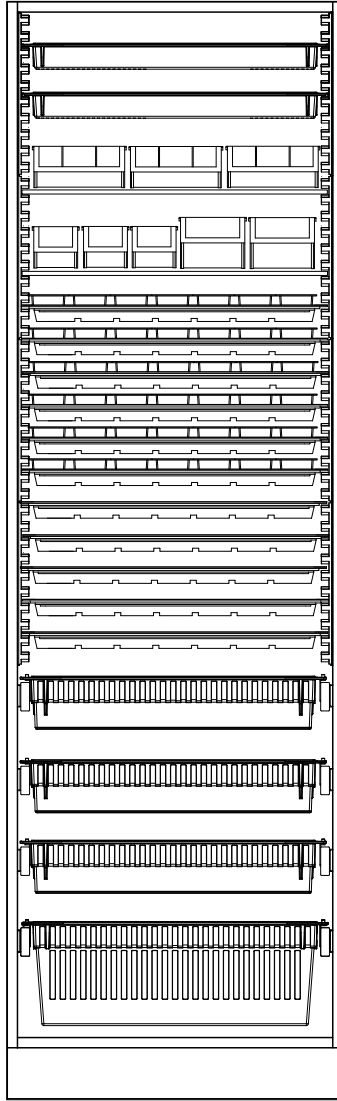
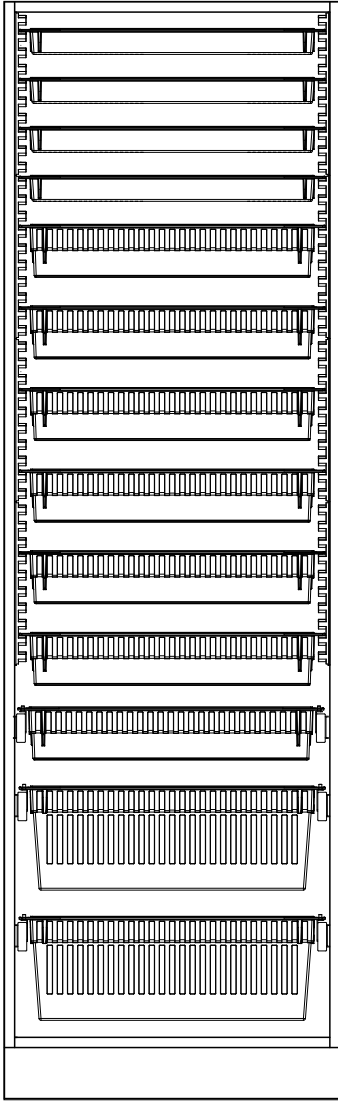

ISO 600 (23 5/8") side panels and full extension runners with modular trays of different heights

ISO 400 (15 3/4") side panels with modular trays of different heights

ISO 400 (15 3/4") side panels and full extension runners with modular trays of different heights

Your cabinet could look like this!
Provide your cabinet storage requirements and we'll create you the perfect solution





Bins and boxes

- | For perfect organization
- | Easy handling
- | More trays, bins and boxes on request

Organization continues
beyond carts and trays

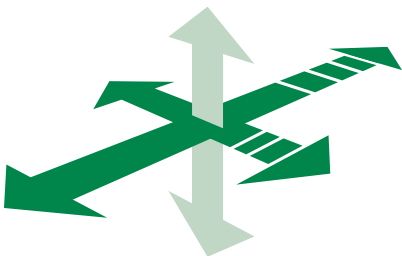

Customized MedTray

- | Any size and various designs possible



Storage bins, stackable

| Plastic transparent

| 202, 203 and 204 stack and combine with each other

| Art. No. | Designation | Size (W x D x H) |
|----------|-------------|--|
| 601031 | No. 202 | 3 x 2 x 1 7/8" (77 x 52 x 48 mm) |
| 601032 | No. 203 | 3 x 4 1/8 x 1 7/8" (77 x 105 x 48 mm) |
| 601005 | No. 204 | 6 1/4 x 4 1/8 x 1 7/8" (158 x 105 x 48 mm) |



601031

601032

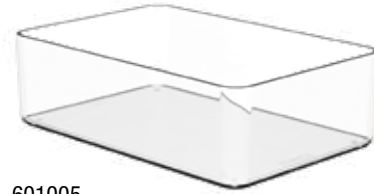

601005



Storage bins with handle 3 5/8" (91 mm)

| Plastic transparent, stackable

| Art. No. | Size (W x D x H) |
|----------|--|
| 601060 | 3 5/8x11 3/4x3 1/4" (91 x 300 x 81 mm) |
| 601061 | 3 5/8x15 3/4x3 1/4" (91 x 400 x 81 mm) |
| 601062 | 3 5/8x19 3/4x3 1/4" (91 x 500 x 81 mm) |
| 601057 | Storage bin divider, transparent |
| 601207 | Storage bin label for width 3 5/8" (91 mm) |

Storage bins with handle 7 1/4" (183 mm)

| Plastic transparent, stackable

| Art. No. | Size (W x D x H) |
|----------|---|
| 601063 | 7 1/4 x 11 3/4 x 3 1/4" (183 x 300 x 81 mm) |
| 601064 | 7 1/4 x 15 3/4 x 3 1/4" (183 x 400 x 81 mm) |
| 601065 | 7 1/4x19 3/4x3 1/4" (183 x 500 x 81 mm) |
| 601058 | Storage bin divider, transparent |
| 601209 | Storage bin label for width 7 1/4" (183 mm) |



Storage bins colored

- Strong storage to keep shelves tidy
- Low front for easy access
- Spot for labels on front
- Will nest together when not in use for concise storage

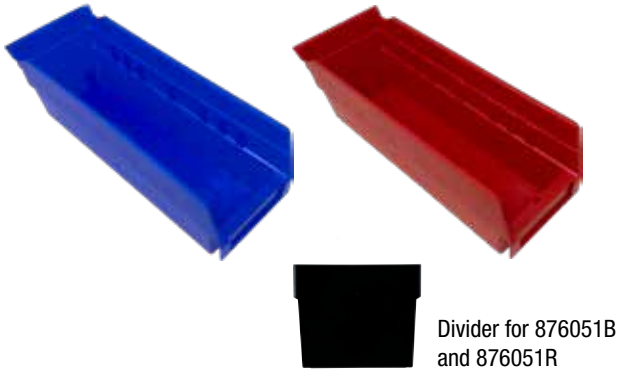

| Art. No. | Description | Size (W x D x H) |
|----------|----------------|-----------------------|
| 876051B | Blue plastic | 4 1/8" x 11 5/8" x 4" |
| 876051R | Red plastic | 4 1/8" x 11 5/8" x 4" |
| 241514 | Divider, black | 4 1/8" x 11 5/8" x 4" |

| Art. No. | Description | Size (W x D x H) |
|----------|--------------|-----------------------|
| 876052B | Blue plastic | 6 5/8" x 11 5/8" x 4" |
| 876052R | Red plastic | 6 5/8" x 11 5/8" x 4" |

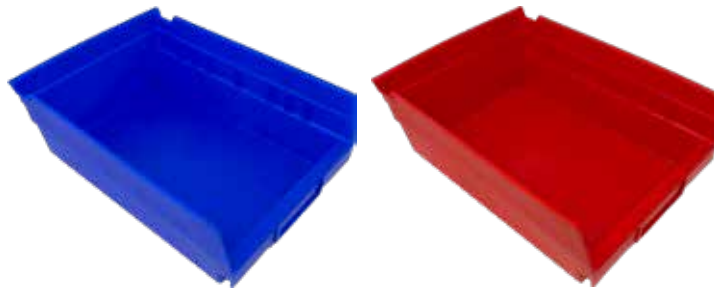
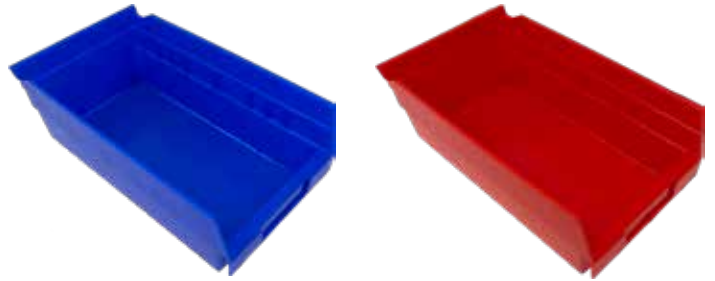

| Art. No. | Description | Size (W x D x H) |
|----------|--------------|-----------------------|
| 876053B | Blue plastic | 8 3/8" x 11 5/8" x 4" |
| 876053R | Red plastic | 8 3/8" x 11 5/8" x 4" |

| Art. No. | Description | Size (W x D x H) |
|----------|--------------|------------------------|
| 876054B | Blue plastic | 11 1/8" x 11 5/8" x 4" |
| 876054R | Red plastic | 11 1/8" x 11 5/8" x 4" |

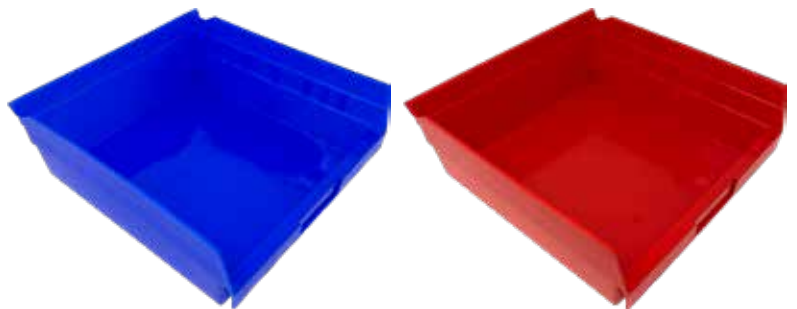

Medication Briefcases



- | Durable hard plastic
- | Handle
- | Becomes tamper evident with tear away seal use
- | Store meds and supplies that can be viewed even when locked

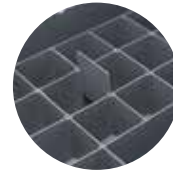

Removable dividers



Seal holes

| Art. No. | Description | Size (W x D x H) |
|----------|--|----------------------------|
| 600604 | Small medication briefcase with seal holes, includes 15 removable dividers | 11 3/4" x 15 1/2" x 2 1/2" |

Tearaway seals for medication briefcases

- | In different colors
- | Serial numbered for tracking

| Art. No. | Description |
|----------|-----------------|
| 840021B | Blue, 8" long |
| 840021G | Green, 8" long |
| 840021R | Red, 8" long |
| 840021Y | Yellow, 8" long |

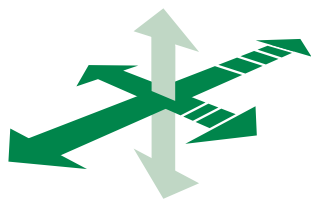
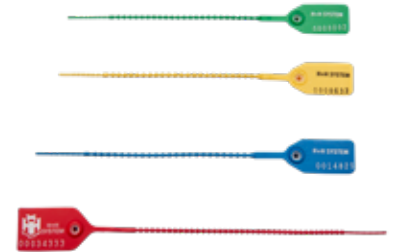

Any width
Any depth
Any height

Narcotic boxes

- | Custom made to any size, any configuration
- | With key or combo lock
- | With optional flexible dividers
- | For any department to secure emergency drugs

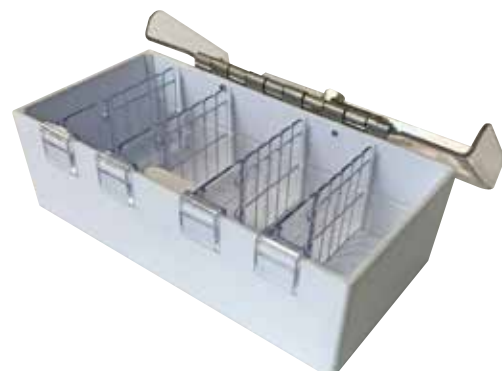
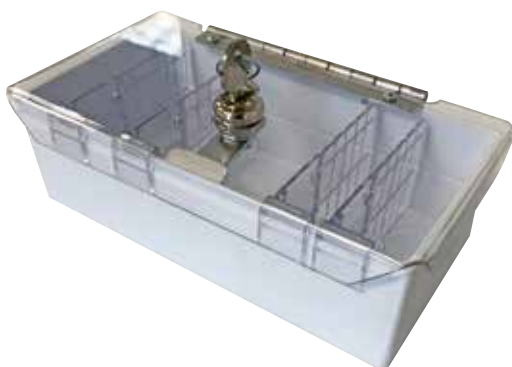



elibox®

The patient box

- | Glasses, dentures and hearing aids always within reach
- | Increased patient comfort and improved safety
- | Reusable, washable outer shell
- | Hygienic disposable blister shell
- | Labeling options
- | Velcro loops attach to bed to stay with patient

The patient box for
personal items, attached
directly to the bedside





elibox® set

- | Bottom, lid, blister shell, 2 hook-and-loop fasteners
- | Material: ABS blue
- | Assembled

| Art. No. | Size (W x D x H) |
|----------|--|
| 600686 | 9 1/16 x 7 11/16 x 2 5/32" (230 x 195 x 55 mm) |

elibox® one-way blister shell

- | For glasses, hearing aids and dentures
- | Material: PET, food safe, recyclable



Art. No.
600681

elibox® hook-and-loop fastener



- | For mounting of elibox® on bedframe
- | 2 pcs per elibox® necessary for attachment to the bed frame

Art. No.
600684

elibox
 by H+H SYSTEM



Flexible shelf dividers

- | Flexible space adjustment
- | Perfect overview
- | Immediate detection of low or empty stock
- | Labeling options
- | Products remain upright at all times
- | Suitable for all stock item sizes
- | Optimal use of space

Optimal overview for immediate detection of empty stock items thanks to H+H organization systems



Dividers with closed front

| Art. No. | Designation |
|----------|---|
| 210106U | L-Profile plastic 35/3 adhesive, H=1 3/8" |
| 240154 | Sliding divider 35/3, H=1 3/8", L=23 5/8" (600 mm) |
| 100046 | Label holder 25/51 with clip 35/9 for label 1 x 2" |
| 210102U | L-Profile plastic 55/3 adhesive, H=2 5/16" |
| 240139 | Sliding divider 55/3, H=2 5/16", L=23 5/8" (600 mm) |
| 100048 | Label holder 25/51 with clip 55/9 for label 1 x 2" |

- | Rails and dividers cut to length
- | Designed to prevent products from falling off shelves – perfect for gravity-fed shelving



- | Rails and dividers cut to length
- | Designed to prevent products from falling off shelves – perfect for gravity-fed shelving

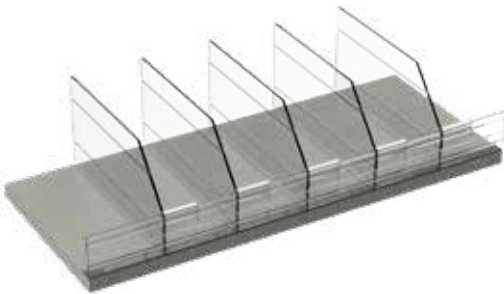

Dividers with closed front, high

| Art. No. | Designation |
|----------|--|
| 210102U | L-Profile plastic 55/3 adhesive, H=2 5/16" |
| 240890 | Sliding divider 200/3, H=8", L=23 5/8" (600mm) |
| 100048 | Label holder 25/51 with clip 55/9 for label 1x2" |

- | Rails and dividers cut to length
- | Easy access to the products



Dividers with closed back

| Art. No. | Designation |
|----------|---|
| 210106U | L-Profile plastic 35/3 adhesive, H=1 3/8" |
| 240154 | Sliding divider 35/3, H=1 3/8", L=23 5/8" (600 mm) |
| 210102U | L-Profile plastic 55/3 adhesive, H=2 5/16" |
| 240139 | Sliding divider 55/3, H=2 5/16", L=23 5/8" (600 mm) |

- | Rails and dividers cut to length
- | Free access to products, easy use

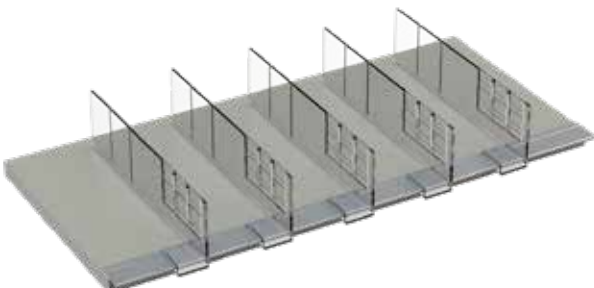

Dividers with aluminum front rail

| Art. No. | Designation |
|----------|--|
| 200302U | Shelf rail aluminum 40/4 adhesive |
| 240302 | Shelf divider 65/3, H=2 1/2", L=13" (330 mm) |

Height of dividers: 2 5/8" (67 mm). The rails can be stuck or screwed to the front of the shelf and protrude 1" (25 mm) outwards. (For consideration when planning cabinet doors and sliding doors.)



Labeling and logistics

- | High visibility
- | Optimized supply chain management
- | Suitable for label sizes
 - Labels 1 x 2"
 - Labels 1 9/16 x 2 3/8" and 2 3/8 x 1 9/16"
 - Labels 3 3/8 x 2 1/8"

Organize your products easily with labels, label holders and labeling rails



Label sleeve 25/51 adhesive

- | Suitable for label 111032W (1 x 2")
- | With adhesive back

Art. No.
100043



Label holder 25/51 adhesive

- | Suitable for label 111032W (1 x 2")
- | With adhesive tape

Art. No.
100044

Label holder 25/51 with clip 35/3

- | Suitable for label 111032W (1 x 2")
- | Clip thickness 1/8" (3 mm)
- | To clip on any H+H divider or rail
- | For any H+H system height
- | Labels exceed products for perfect overview

Art. No.
100045

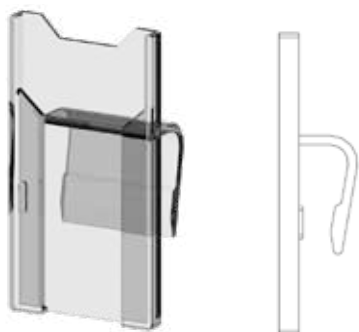
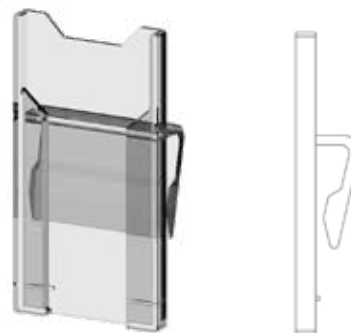

Label holder 25/51 with clip 35/9

- | Suitable for label 111032W (1 x 2")
- | Clip thickness 3/8" (9 mm)
- | To clip on any H+H divider clip
- | Labeling "moves" with product

Art. No.
100046

Label holder 25/51 with clip 55/3

- | Suitable for label 111032W (1 x 2")
- | Clip thickness 1/8" (3 mm)
- | To clip on any H+H divider or rail
- | For H+H system heights 2 5/16" and higher

Art. No.
100047

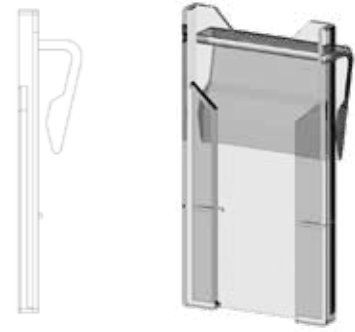

Label holder 25/51 with clip 55/9

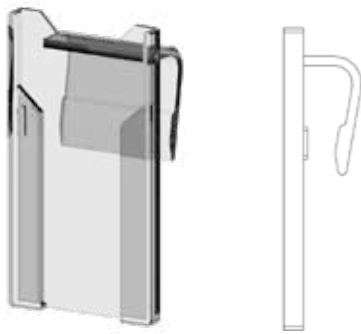

- | Suitable for label 111032W (1 x 2")
- | Clip thickness 3/8" (9 mm)
- | To clip on any H+H divider clip
- | For H+H system heights 2 5/16" and higher
- | Labeling "moves" with product

Art. No.
100048

Label holder 40/54 with clip and hooks

- | Suitable for label 100188 (1 9/16 x 2 1/8")
- | Vertical and horizontal clip function
- | For modular trays, dividers, etc.

| Art. No. | Designation |
|----------|-------------|
| 100067 | transparent |



Label holder 40/60 PC adhesive

- | Suitable for label K100185 (1 9/16 x 2 3/8")
- | With adhesive tape

| Art. No. | Designation |
|----------|-------------|
| 100062 | transparent |



Label holder 40/60 with clip and hooks

- | Suitable for label K100185 (1 9/16 x 2 3/8")
- | Vertical and horizontal clip function
- | For modular trays, dividers, etc.

| Art. No. | Designation |
|----------|-------------|
| 100060 | transparent |

Label holder 60/40 adhesive

- | Suitable for label K100185 (2 3/8 x 1 9/16")
- | With adhesive tape
- | Optional transparent cover for label

| Art. No. | Designation |
|----------|--------------------------------|
| 100058 | Label holder 60/40 PC adhesive |
| 100073 | Cover for label holder |



Label holder 60/40 with clip and hooks

- | Suitable for label K100185 (2 3/8 x 1 9/16")
- | Vertical and horizontal clip function
- | Optional transparent cover for label

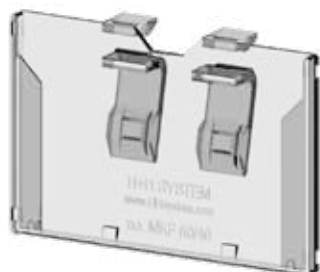

| Art. No. | Designation |
|----------|------------------------|
| 100059 | transparent |
| 100073 | Cover for label holder |

Label holder 85/54 adhesive

- | Suitable for label K100187 (3 3/4 x 2 1/8")
- | With adhesive tape

| Art. No. |
|----------|
| 100077 |

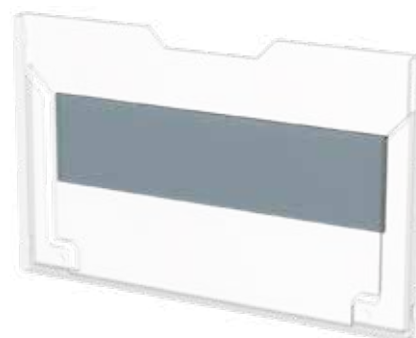



Label holder 85/54 with clip and hooks

- | Suitable for label K100187 (3 3/8 x 2 1/8")
- | Vertical and horizontal clip function
- | Available in transparent and various colors

| Art. No. | Designation |
|-----------|-------------|
| 100072 | transparent |
| 100072-bl | blue |
| 100072-gr | green |
| 100072-or | orange |
| 100072-rt | red |



Labeling rail, adhesive

- | Transparent
- | With adhesive tape

| Art. No. | Size (W x H) |
|----------|----------------------------|
| 7972350 | 13 3/4" x 1" (350 x 25 mm) |



Labeling rail

- | For ISO modular trays

| Art. No. | Size (W x H) |
|----------|------------------------------|
| 7971060 | 2 3/8 x 1 9/16" (60 x 40 mm) |

Label cardstock 1 x 2" blank

- | 44 labels per sheet
- | Perforated cardstock

| Art. No. | Description |
|----------|-------------|
| 111032W | White label |

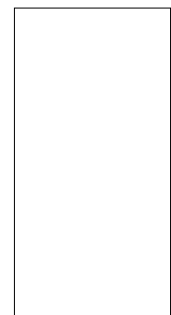

Label cardstock 1 x 2" preprinted

- | 36 labels per sheet
- | Perforated cardstock

| Art. No. | Description |
|----------|-------------|
| 111031W | White label |



Label 1 9/16 x 2 1/8"

- | For label holder 100067
- | Plastic white, blank
- | Thickness 1/64" (0,5 mm)

| Art. No. | Description |
|----------|------------------------------|
| 100188 | 1 9/16 x 2 1/8" (40 x 54 mm) |

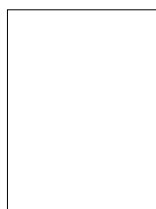

Label 2 3/8 x 1 9/16"

- | For label holder 100059 and 100060
- | Plastic white, blank
- | Thickness 1/64" (0,5 mm)

| Art. No. | Description |
|----------|---------------------|
| K100185 | 60 x 40 mm – 0,5 mm |

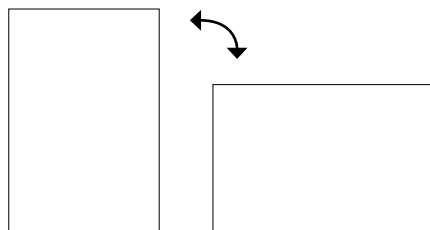

Label 3 3/8 x 2 1/8"

- | For label holder 100072 with clip or 100077 with adhesive tape
- | Plastic white, blank
- | Thickness 1/64" (0,5 mm)

| Art. No. | Description |
|----------|-----------------------------|
| K100187 | 3 3/8 x 2 1/8" (85 x 54 mm) |





Refrigerator storage

- | Efficient with our flexible divider system
- | Optimal use of space
- | Material: aluminum or plastic

H+H SYSTEM produces
drawers for medicines
and blood standard



AluCool® drawer

- | AluCool effect: high-quality aluminum provides stable and consistent temperature
- | Solid and long lasting
- | Easy to pull out due to plastic rollers
- | Tool-free assembly
- | Any divider configuration
- | Subsequent adjustment of the organization system using dividers and rails
- | Hygienic due to the aluminum surface



H+H MedTray

- | Flexible dividers
- | Any size and configuration possible
- | Corners available in white, blue, green and red

More H+H MedTrays under cart and drawer organization



Blood bank dividers

- | Optimal overview and precise storage for blood and plasma bags



Drawer for refrigerator Liebherr LRB05G1HC and LRB05W1HC

- | Max vaccine storage system
- | Integrated flexible divider system
- | Max 4 drawers
- | Sliding roller drawers
- | Holds 300 vials per drawer
- | Makes up to 15 compartments



| Art. No. | Description |
|----------|-------------------|
| 306120U | Ventilated drawer |
| 306121U | Solid drawer |

Drawer for refrigerator Liebherr LRB23W1HC

- | Max vaccine storage system
- | Integrated flexible divider system
- | Max 9 drawers
- | Sliding roller drawers
- | Holds 600 vials per drawer
- | Makes up to 24 compartments



| Art. No. | Description |
|----------|-------------------|
| 306124U | Ventilated drawer |
| 306125U | Solid drawer |

Drawer for refrigerator Liebherr LRT21G1HC

- | Max vaccine storage system
- | Integrated flexible divider system
- | Max 13 drawers
- | Sliding roller drawers
- | Holds 500 vials per drawer
- | Makes up to 21 compartments



| Art. No. | Description |
|----------|-------------------|
| 306126U | Ventilated drawer |
| 306127U | Solid drawer |

Drawer for refrigerator Liebherr LRT30W1HC

- | Max vaccine storage system
- | Integrated flexible divider system
- | Max 13 drawers
- | Sliding roller drawers
- | Holds 1050 vials per drawer
- | Makes up to 36 compartments



| Art. No. | Description |
|----------|-------------------|
| 306128U | Ventilated drawer |
| 306129U | Solid drawer |



Cold room organization

- | Storage shelves made of high quality aluminum
- | Modularly expandable
- | Usable as a stationary unit or as a mobile unit on casters

H+H FLEXSHELF®

Also checkout the
H+H FlexShelf chapter





Medication distribution

- | Dispensers for daily distribution of medication
- | Labels for designation of patient name, date, medication, and delivery time
- | Week trays provide an easy transportation or distribution of multiple medications
- | Dispensing trays for a clear delivery of medication

Medication distribution -
organization at its best



ISO dispensing trays 11 3/4 x 15 3/4" (300 x 400 mm) for blisters



- | ISO dispensing tray #16 for blisters
- | For 32 patients
- | Suitable for up to 32 blister bags



Art. No.

7940135

Label holder 60/40

- | Suitable for label K100185 (2 3/8 x 1 9/16")
- | Optional label
- | Optional transparent cover for label holder

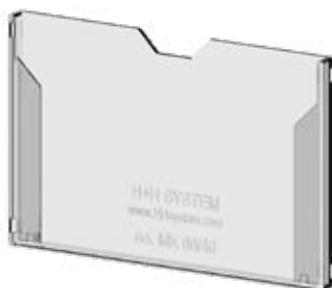

| Art. No. | Designation |
|----------|-----------------------|
| 100057 | Label holder 60/40 PC |
| K100185 | Label 2 3/8 x 1 9/16" |

Medi cup 25 ml

| Art. No. | Color |
|----------|--------|
| W71.1 | white |
| W71.2 | yellow |
| W71.3 | blue |
| W71.4 | red |
| W71.5 | green |



Lid for medi cup

- | Tight close



Art. No.
W72

ISO dispensing trays 11 3/4 x 15 3/4" (300 x 400 mm)



- | ISO dispensing tray #1
- | For 8 patients
- | Incl. 32 cups for 4 application times

Art. No.
7940120



- | ISO dispensing tray #12
- | For 8 patients
- | Incl. 24 cups and 8 label holders for 3 application times

Art. No.
7940133



- | ISO dispensing tray #13
- | For 4 patients
- | Incl. 16 white cups for 4 application times

Art. No.
7940134

Optimal use of space
**Efficient medication
distribution thanks to
diverse variations and
insert options**



ISO dispensing trays 11 3/4 x 15 3/4" (300 x 400 mm)

- | For 32 patients
- | Incl. 32 cups



- | ISO dispensing tray #3
- | Application time **morning**

Art. No.
7940122

- | For 16 patients
- | Incl. 16 cups and label holders



- | ISO dispensing tray #8
- | Application time **morning**

Art. No.
7940129



- | ISO dispensing tray #4
- | Application time **noon**

Art. No.
7940123



- | ISO dispensing tray #9
- | Application time **noon**

Art. No.
7940130



- | ISO dispensing tray #5
- | Application time **evening**

Art. No.
7940124



- | ISO dispensing tray #10
- | Application time **evening**

Art. No.
7940131



- | ISO dispensing tray #6
- | Application time **night**

Art. No.
7940125



- | ISO dispensing tray #11
- | Application time **night**

Art. No.
7940132



Human barrier products by H+H SYSTEM

H+H SYSTEM's
protection products
guarantee maximum
safety



V-shield

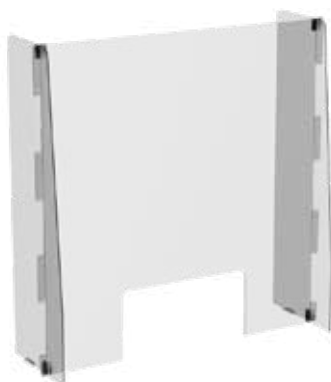

- | Sneeze and cough protection for your environment
- | Optional fixation on counter or desk
- | Acrylic side barriers lock into front piece to create your three sided free-standing safe guard
- | Easy relocation to other sales points

| Art. No. | Nominal size (W x H) |
|----------|--------------------------|
| 44299 | 20 x 36" (500 x 903 mm) |
| 44294 | 24 x 36" (600 x 903 mm) |
| 44295 | 28 x 36" (700 x 903 mm) |
| 44296 | 32 x 36" (800 x 903 mm) |
| 44297 | 36 x 36" (900 x 903 mm) |
| 44298 | 40 x 36" (1000 x 903 mm) |

V-shield plus

- | Stable aluminium posts on plastic feet
- | Modular expansion possible
- | Multi-part acrylic glass panes with an overlapping effect
- | Easy, tool-free assembly and disassembly thanks to plastic plug-in screws

| Art. No. | Description | Nominal size (W x H) |
|----------|-----------------------|--------------------------|
| 44600 | 3 acrylic glass panes | 36 x 77" (909 x 1955 mm) |
| 44601 | 3 acrylic glass panes | 24 x 77" (609 x 1955 mm) |
| 44604 | 2 acrylic glass panes | 36 x 62" (909 x 1580 mm) |
| 44605 | 2 acrylic glass panes | 24 x 62" (609 x 1580 mm) |
| 44610 | additional pane | 36 x 18" (900 x 451 mm) |
| 44612 | additional pane | 24 x 18" (600 x 451 mm) |

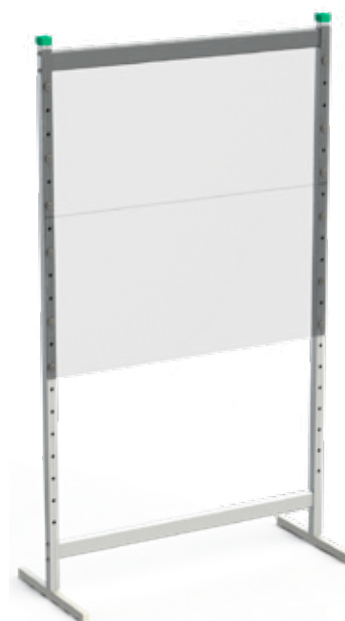

V-shield pro commercial

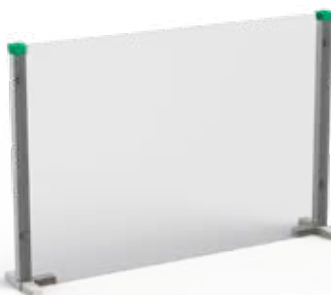

- | Combination of aluminium and acrylic glass
- | Tool-free assembly and easy disassembly
- | Store individual parts flat after dismantling and assemble quickly in case of need
- | Easy relocation to other sales points

| Art. No. | Nominal size (W x H) |
|----------|-------------------------|
| 44606 | 24 x 24" (608 x 600 mm) |
| 44607 | 24 x 36" (608 x 900 mm) |
| 44621 | 32 x 36" (808 x 900 mm) |
| 44622 | 32 x 24" (808 x 600 mm) |
| 44608 | 36 x 36" (908 x 900 mm) |
| 44609 | 36 x 24" (908 x 600 mm) |



Perfection and quality
Made in USA & Austria

H+H SYSTEM, Inc.

760 Beechnut Drive

Pittsburgh, PA 15205

Phone 412-922-4437 | 800-477-2123

Fax 412-922-4362 | 800-477-9364

salesus@HHsystem.com

www.HHsystem.com

10/2023

Phrase and literal mistakes subject to alteration.



H+H SYSTEM, Inc.
760 Beechnut Drive
Pittsburgh, PA 15205
Phone 412-922-4437 • 800-477-2123
Fax 412-922-4362 • 800-477-9364
salesus@HHsystem.com
www.HHsystem.com